



**HAL**  
open science

## How to Produce a Reference Trajectory for Studying GNSS Errors in Urban Environments

David Bétaille, François Peyret, O Nouvel, W Vigneau, G Duchateau, H Secretan

► **To cite this version:**

David Bétaille, François Peyret, O Nouvel, W Vigneau, G Duchateau, et al.. How to Produce a Reference Trajectory for Studying GNSS Errors in Urban Environments. ENC GNSS "Toulouse Space Show", Apr 2008, Toulouse, France. hal-04505212

**HAL Id: hal-04505212**

**<https://univ-eiffel.hal.science/hal-04505212>**

Submitted on 14 Mar 2024

**HAL** is a multi-disciplinary open access archive for the deposit and dissemination of scientific research documents, whether they are published or not. The documents may come from teaching and research institutions in France or abroad, or from public or private research centers.

L'archive ouverte pluridisciplinaire **HAL**, est destinée au dépôt et à la diffusion de documents scientifiques de niveau recherche, publiés ou non, émanant des établissements d'enseignement et de recherche français ou étrangers, des laboratoires publics ou privés.

# How to Produce a Reference Trajectory for Studying GNSS Errors in Urban Environments

D. Bétaille<sup>1</sup>, F. Peyret<sup>1</sup>, O. Nouvel<sup>2</sup>, W. Vigneau<sup>2</sup>, G. Duchateau<sup>3</sup>, H. Secretan<sup>4</sup>

<sup>1</sup>Laboratoire Central des Ponts et Chaussées, Nantes, France

<sup>2</sup>M3Systems, Toulouse, France

<sup>3</sup>Thales Alenia Space, Toulouse, France

<sup>4</sup>Centre National des Etudes Spatiales, Toulouse, France

## BIOGRAPHY

David Bétaille is a researcher in the Division for Metrology and Sensor Instrumentation of the LCPC, where his current activity relates to vehicles positioning by satellites systems combined with dead-reckoning and mapping. ADAS and in general road safety applications compose the research context of his lab. He received his PhD in 2004 for his investigations at University College London on phase multipath in kinematic GPS.

François Peyret, ENSMA-Sup'Aero Eng. 1973, is Director of Research (equivalent of Professor), and head of the "Image processing and geopositioning" research team, at the *Laboratoire Central des Ponts et Chaussées*, where he is leading research activities in the field of road vehicle positioning for ADAS, especially with hybrid GNSS systems and enhanced 3D map-matching.

Olivier Nouvel is a Radio Navigation Engineer at M3Systems (Toulouse) since 2002. He is involved in various RadioNavigation projects (GPS, SBAS, GNSS2...) and is specialized in modelling and simulation of RN signal processing chain (Galileo signals, effect of interference/multipath).

Willy Vigneau is head of the Radio Navigation Unit at M3Systems. Graduated as a telecommunication engineer from Sup'Aero in 1999, he joined M3S, a French SME involved in various RN projects: GPS/EGNOS/Galileo signal processing and critical applications of GNSS.

Grégoire Duchâteau is Eng. graduated from Sup'Aero (Toulouse). He joined Alcatel in 1991 and has worked in several areas related to fault tolerance, supervision and control for both wireless telecommunication and transport (rail, road, space) applications. Since 2003 he is technical manager of the Transport solution developed by the navigation business unit of Thales Alenia Space France.

Hugues Secretan is an expert in satellites navigation systems. He joined the CNES (the French Space Agency) in 1983 after graduating with a degree in electrical and mechanical engineering. He works in the ESA EGNOS Project Office in Toulouse since 1998. He is now in charge of the SPEED system aiming to support the European GNSS Evolution Program launched in 2007.

## ABSTRACT

Very active research investigations in the domain of terrestrial navigation have to face the problem to establish the true trajectory, to which relevant comparison could be made. Digital maps, despite their increasing accuracy, do not solve the problem. After a brief introduction of the general frame of the study (i.e. navigation with GPS EGNOS in urban environments), the authors present the instrumentation they set-up on board a test vehicle, based on IXSEA LandINS inertial measurement unit hybridized with kinematic GPS and odometry. The reference trajectory obtained is analysed, with the aim of qualifying its accuracy.

## 1. INTRODUCTION

Research is extremely active in the domain of positioning systems based upon GNSS and hybridization with other sensors, to cope with the weaknesses of pure satellite systems in constrained environments. In this respect, many research laboratories and industrial companies propose their solution, generally based upon Kalman filtering or similar data fusion approaches. When time comes for assessing the technical performances of these systems in the environment they have been designed for, generally urban environments, they have to face the difficult problem to establish the true trajectory.

Generally, two kind of solutions are proposed: the first one consists in plotting the system output on a digital map and to more or less check that they fit together: it is no use to stress the poor quality of this comparison, especially when you have no idea of the accuracy of the digital map. Moreover, even if digital maps were precise enough, the degree of freedom of the trajectory on the roadway still makes it necessary additional measurements. Hence, the second solution consists in trying to produce an accurate reference trajectory using a kinematic dual frequency GPS trajectory (RTK or PPK). In this second case, the sad thing is that in the environments concerned, the kinematic trajectory, based on phase-differential GPS, is even less available than the code-only solutions.

The solution the paper will describe is based upon the usage of a navigation-grade inertial measurement unit (IMU) hybridized with a PPK processing and the methodology used for the design of the test circuit.

In the first part of the paper, the authors will introduce the general frame of the study, which is the research of relevant GNSS observables error models in urban environments to be used in EGNOS integrity algorithms in place of the standard models established for an aircraft environment, driven by the CNES.

Then, they will recall the utilization constraints of the PPK computation, linked to the ambiguity resolution problem and they will introduce the IMU that has been used and its performances, guarantying the required accuracy of 25cm RMS only if the lengths of the PPK position outages do not exceed 3 minutes. The circuits that have been driven in Toulouse will then be described and finally the result in terms of availability and accuracy of the obtained reference trajectory will be presented. The 24 hours campaign of tests reported here is much larger than preceding experiments [1][2].

## 2. ON-BOARD INSTRUMENTATION

The on-board instrumentation for the reference trajectory is composed of:

- the Inertial Measurement Unit LandINS by IXSEA
- an odometer mounted on the left rear wheel (a wheel that is not engine powered)
- a Septentrio dual-frequency GPS receiver (Novatel 402 GG antenna)
- a Scorpio dual-frequency GPS receiver (same antenna)

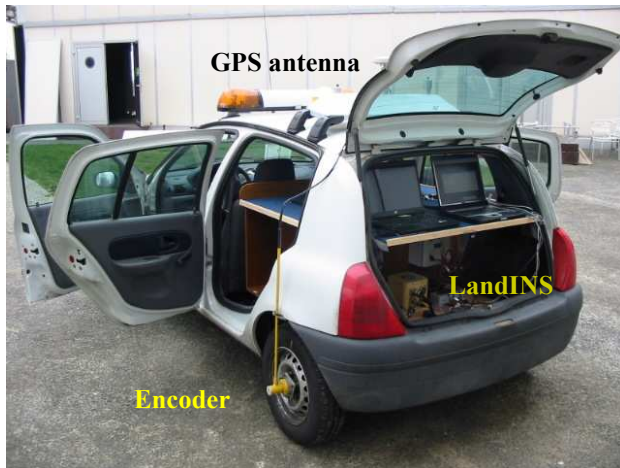

Figure 1 - the LCPC equipped vehicle

### 2.1 POST-PROCESSED KINEMATIC GPS

The on-board dual-frequency GPS receivers log their raw data of code and phase (convertible in RINEX format if necessary). These data will be post-processed together with similar data collected at a local base station, using THALES GNSS Solutions software: this gives a first PP Kinematic GPS trajectory.

Note that the permanent station *TLLA* of the national network RGP-TERIA has been selected as the base station for post-processing, with a backup solution in Toulouse ENAC (both are permanent stations situated at a distance of a few kilometers from the city centre).

### 2.2 LANDINS

LandINS is an Inertial Navigation System that makes loosely coupling of its own strap-down IMU with GPS navigation points and odometry in Real Time.

LandINS is manufactured by IXSEA in France: the IMU contains three pendulum accelerometers and three navigation-grade fiber-optics gyrometers.

For specific studies like our where Real Time trajectory is not necessary, the IMU raw data can be logged on a PC terminal for further computation off-line, which makes it possible backward smoothing in addition to the usual Extended Kalman Filter that runs on-board. The post-processing software of LandINS has also been developed by IXSEA and it is called PopINS.

LandINS can work in autonomous mode, i.e. in pure inertial mode. Only the internal accelerometers and gyrometers are used in this case. This is not the most current working mode. Actually, in order to benefit of the most advanced performances of LandINS, it must be hybridized with a GPS receiver and an odometer. In practice, the pure inertial mode is never activated alone, because whenever the GPS receiver is masked, the odometer continues its measurement of the performed distance.

The IMU materializes a frame, as shown in Figure 1, whose x axis is close to the vehicle forward direction, z axis is close to the vertical when the vehicle pitch and roll are null, y axis makes orthonormal xyz frame.

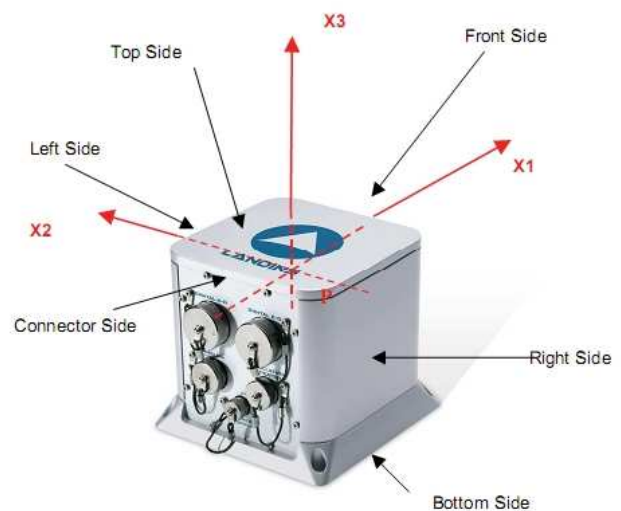

Figure 2 - IMU body frame

In the IMU body frame, we have measured (with an accuracy of the order of magnitude of the centimeter) the following lever arms:

- odometer
- primary GPS antenna (the one used in the coupling process of LandINS)
- every other antennas placed on the vehicle roof for the purpose of the study, whose reference trajectories will be calculated at the end.

Odometer and primary GPS antenna lever arms are used in the hybridization: it is also possible to observe these parameters within the Extended Kalman Filter that runs in Real Time. We could check the perfect exactitude of both direct measurements and on-line identified parameter.

Last but not least, a value of the odometer step has been calibrated riding between two static PPK GPS points 500m distant (which is enough for the  $10^{-4}$  expected value of precision of this parameter of 10cm a priori). This step has also been confirmed by the EKF of LandINS (since it is also an observable parameter of the process).

### 3. TUNING OF POPINS

Tuning of PopINS were achieved by IXSEA and the LCPC on a data set made during a preliminary test. Actually, default tuning parameters had to be customized for the need of the study, for which accuracy has higher importance than robustness. A 10km circuit around the LCPC (near Nantes) has been planned with no GPS mask, which guarantees continuous kinematic GPS positioning with a level of accuracy of a couple of centimeters. The RGP permanent station *NANT* was used.

Series of « artificial » masks have been applied to the PPK solutions used by PopINS, and we computed the deviation between the PopINS trajectory and the continuous PPK trajectory. A total number of 51 masks of a duration of 2 minutes were simulated, randomly located along the circuit.

Next graphics show the INS deviation components in latitude, longitude and altitude for the total population (51 masks) and the corresponding statistics (RMS, mean and standard deviation). Real Time EKF LandINS results are shown first (cf. Figure 3), followed by Post Process PopINS ones (cf. Figure 4).

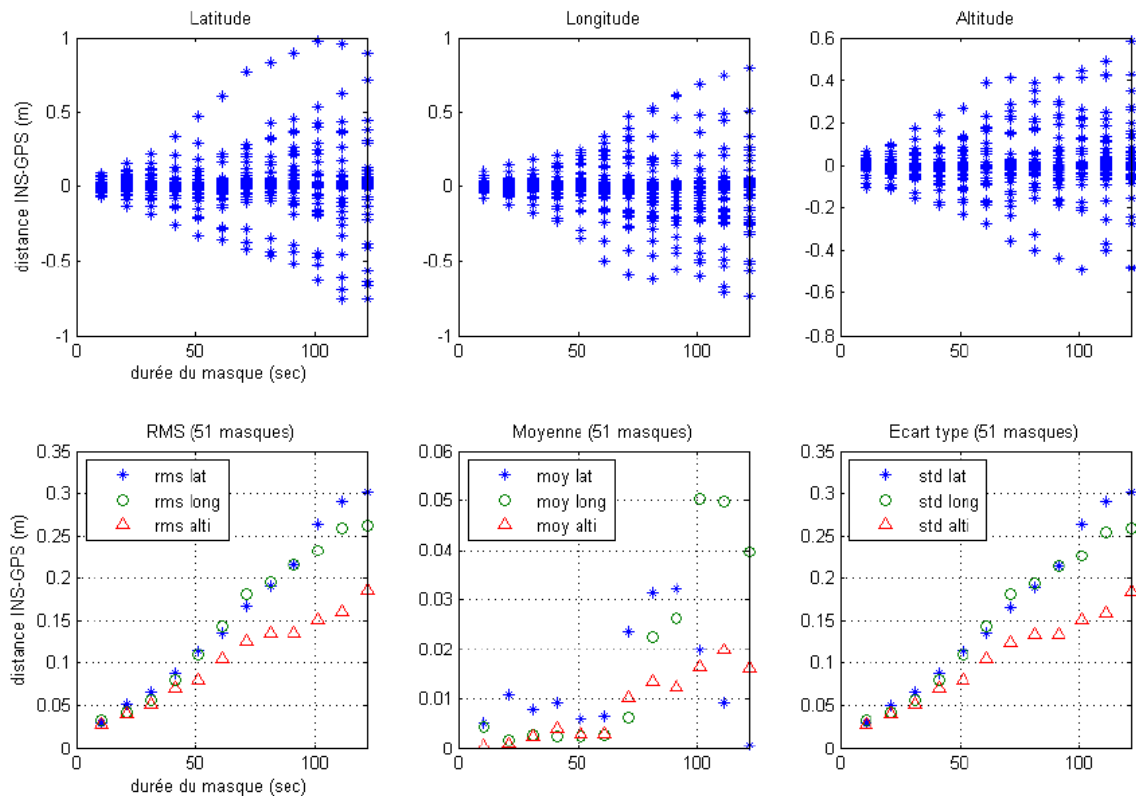
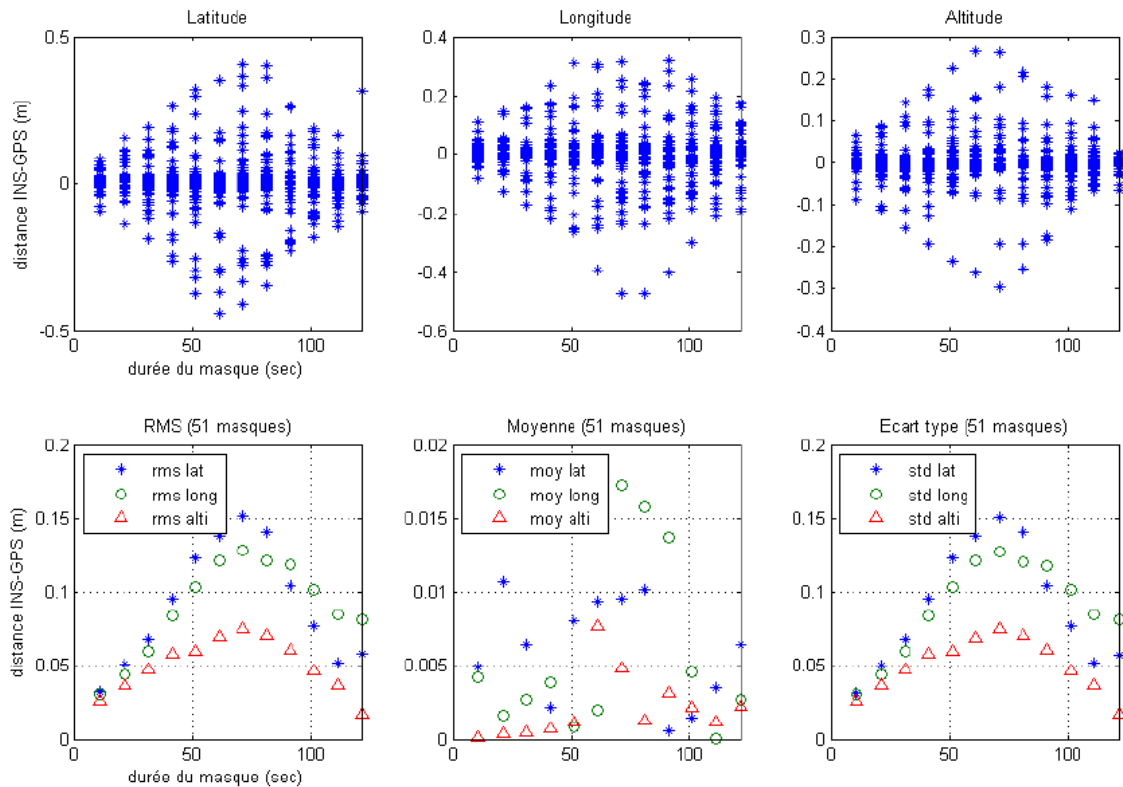

Figure 3 - preliminary test results of Real Time EKF LandINS



**Figure 4 - preliminary test results of Post Processed PopINS**

These graphics enable us to conclude about the ability of LandINS to localize without fixed and accurate GPS solutions:

- deviations are statistically centred: there is no systematic direction for drift, which means that the biases of the sensors have been compensated;
- once tuned, the positioning error of LandINS has an order of magnitude of 1 decimetre after 1 minute (10 to 15cm), and 20 to 30cm after 2 minutes in Real Time;
- the vertical error grows slower than the horizontal error;
- deviations are quasi linear functions of time;
- as a consequence of this last point, Post Processing PopINS error will remain below 15cm for 2 minutes PPK GPS outage. Actually, backward smoothing bounds the positioning error to the level it reaches at middle of mask duration. Note that these results are given at 1 RMS.

#### 4. METHODOLOGY OF THE EXPERIMENT

In order to enable kinematic GPS ambiguity resolution regularly along the circuit, which requires 1 minute of continuous observations of both L1-L2 phases (sometimes more depending on the number of satellites in view), it appeared necessary to carry out the experiment in “stop and go”, as follows: « stop (2 min) and go (3 min) ». The weakness of L2 in urban environment actually causes very difficult “on the fly” ambiguity resolution. Moreover, we agreed on trying not to exceed 3 minutes of navigation with potentially no fixed and accurate kinematic GPS solution, after which duration LandINS drift would not be acceptable for the assessment of EGNOS (we aim at producing a reference trajectory with maximum deviation below 25cm RMS).

- Three sessions were scheduled, covering 24 hours:
- 4 December 2007, from 10h to 19h local time;
  - 5 December, from 04h to 10h local time;
  - 5 to 6 December, from 19h to 04h local time.

Each session was split into 3 hours data collections, that always started and stopped in THALES facilities in zone 3 (rural area). Most of the time was spent in zone 2 (sub-urban area) with several passes in zone 1 (city centre) when the GPS constellation was the best (cf. Figure 5).

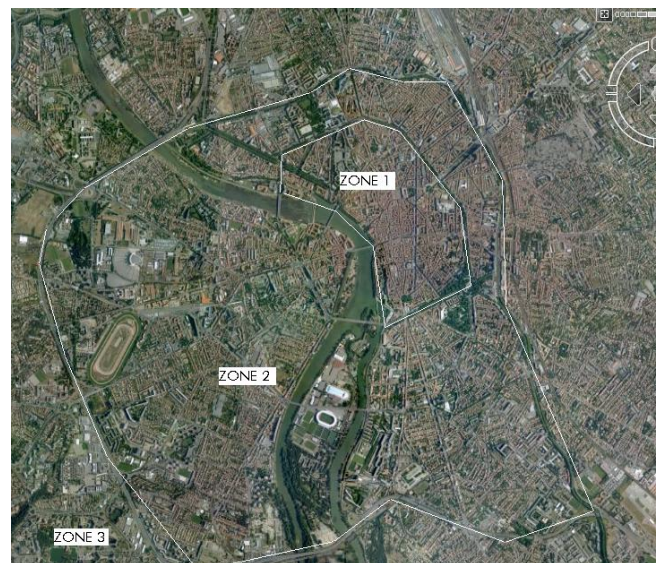

**Figure 5 - city center, sub-urban and rural areas**



## 5. KINEMATIC GPS AVAILABILITY

*TLIA* base station 1s data were always used. Both Scorpio and Septentrio kinematic observations were post-processed with *TLIA* and compared. The post-processing software used was GNSS Solutions by Thales Navigation with default parameters.

The following tables compare, for each session and hour per hour the availability of fixed and accurate GPS solutions. The indications in columns are: test duration in s, number of solutions fixed (in term of phase integer ambiguities) and accurate enough (i.e. whose predicted RMS is lower than 5cm, either on horizontal or vertical components) in s (observations at 1 Hz), the ratio of this number with respect to the test duration in %, and the duration of the larger « mask » (i.e. the larger interval during which the IMU and the odometer will be hybridized with no kinematic GPS solution) in s. The last column indicates the number of these intervals that exceed 5 minutes.

Columns 3 to 6 concern Scorpio, 7 to 10 Septentrio.

Session 1 (10h to 19h local time).

10h	3620	2324	64.2	320	2	2788	77.0	188	0
11h	3662	940	25.7	279	0	1935	52.8	282	0
12h	3027	575	19.0	452	1	2061	68.1	182	0
13h	2737	2061	75.3	335	2	2119	77.4	144	0
14h	3472	1531	44.1	476	2	2198	63.3	350	1
15h	3050	1781	58.4	571	1	2103	69.0	179	0
16h	3479	2415	69.4	318	1	2553	73.4	194	0
17h	3130	1620	51.8	511	2	1753	56.0	443	1
18h	2362	1417	60.0	474	2	1729	73.2	314	1

Session 2 (04h to 10h local time).

04h	3679	2261	61.5	393	2	2758	75.0	152	0
05h	3502	1939	55.4	312	1	2187	62.5	238	0
06h	3425	2342	68.4	410	1	2368	69.1	222	0
07h	3460	2883	83.3	151	0	2852	82.4	212	0
08h	3416	1260	36.9	616	3	2051	60.0	245	0
09h	3710	2094	56.4	201	0	2764	74.5	188	0

Session 3 (19h to 04h local time).

19h	3629	2980	82.1	170	1	2685	74.0	171	0
20h	2989	1649	55.2	515	1	1643	55.0	572	1
21h	3734	2223	59.5	278	0	2205	59.1	302	1
22h	3360	2745	81.7	148	1	2433	72.4	162	0
23h	3458	1980	57.3	387	1	1847	53.4	169	0
00h	3486	1713	49.1	329	1	1464	42.0	194	0
01h	3575	1667	46.6	349	1	2014	56.3	487	1
02h	3474	1144	32.9	991	2	1826	52.6	229	0
03h	3863	891	23.1	588	2	963	24.9	776	1

These tables show that the Septentrio is much more successful in fixing the ambiguities than the Scorpio, which indicates that the Septentrio observations are globally less perturbed than the Scorpio observations.

Scorpio is a receiver of 10 year old, against 2 for Septentrio. It was mainly designed for static applications (surveying and topometry). The L1 and L2 sensitivity threshold under which the Scorpio stops tracking are higher than those of the Septentrio, whose sensitivity has been optimized for GPS kinematic applications.

For further computation of the reference trajectory, the Septentrio solutions were used in PopINS. The longest interval with no fixed and accurate kinematic solution lasts approximately 13 minutes. There are only 7 similar outages that last more than 5 minutes over the whole campaign of tests with Septentrio (but 30 with Scorpio).

## 6. ANALYSIS OF THE FILTERING / SMOOTHING ERRORS IN THE CAMPAIGN OF TESTS

PopINS software by IXSEA has been used to post-process LandINS measurement. This software can be set-up to simulate Real Time, i.e. filter only (forward process only) as well as filter and smooth (including backward process), which is the ultimate output in term of accuracy.

### 6.1 FILTERING ERROR (REAL-TIME)

Tuning are those obtained on the preliminary test (cf. section 3). They showed that the positioning error grows linearly with time, with the assumption of almost uniform speed. We know that the error after smoothing corresponds to that of filtering at mid-mask. Therefore, it comes out that the filtering error at the end of a period where kinematic GPS was lost would give an interesting indication of the error of the reference trajectory in the same period (i.e. twice error).

The filtering error can obviously be obtained by computing the difference between the filtered trajectory (similar as that obtained in Real Time) and the smoothed trajectory (i.e. the reference trajectory). For instance, next graphics (cf. Figure 6) shows this difference for 1 hour test:

- dotted line figures out the Real Time error envelop (filtering error envelop), this error (or to be exact its approximation by the difference between filtered and smoothed trajectories) being represented in solid line;
- bold line figures out the Post Process error envelop (smoothing error envelop) predicted by PopINS, and that is supposed to bound the error of the reference trajectory.

The availability of PPK fixed and accurate solutions is visible along x axis.

The analysis of the series of graphics obtained similarly for the 24 hours of test shows that the horizontal error at the end of dead-reckoning periods generally does not exceed 1m, even of for some rare cases it can reach 2m. This confirms the a priori expected 50cm RMS of the preliminary test (i.e. 95% in 1m) for 3 minutes duration of kinematic GPS outage for a normal distribution of the dead-reckoning error.

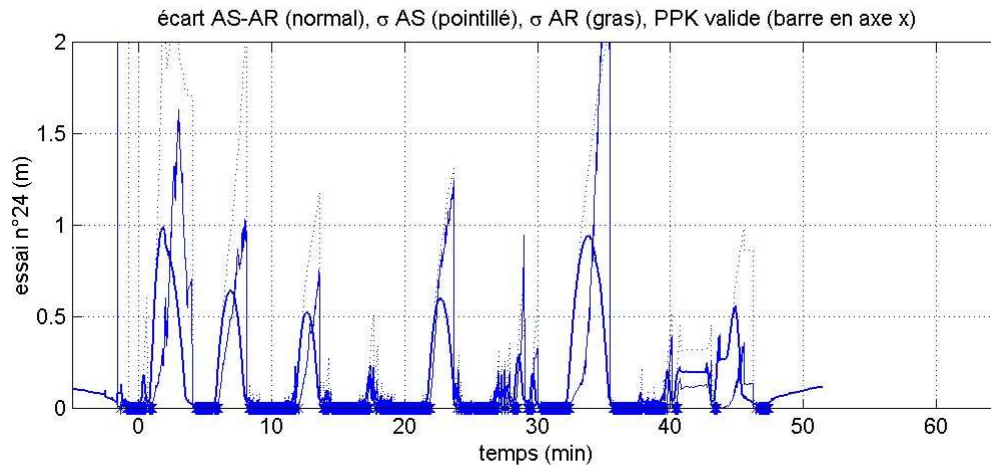

**Figure 6 - filtering and smoothing error envelopes for test n°24**

In the following tables, we count the number of periods with no fixed and accurate kinematic solutions whose duration exceeds 30 seconds and the number of these periods that caused a dead-reckoning error above 1m horizontally.

Session 1 (10h to 19h local time).

10h	7	1
11h	12	1
12h	6	1
13h	5	0
14h	9	0
15h	8	1
16h	5	1
17h	7	1
18h	3	0

Session 2 (04h to 10h local time).

04h	6	0
05h	8	1
06h	5	2
07h	5	0
08h	9	0
09h	8	1

Session 3 (19h to 04h local time).

19h	6	0
20h	6	0
21h	7	0
22h	7	1
23h	11	2
00h	7	3
01h	7	1
02h	8	1
03h	9	4

The horizontal error exceeded 1m for only 22 dead-reckoning periods (out of a total number of 172). During these kinematic GPS outages, the maximum error of the reference trajectory might exceed 0.5m.

## 6.2 SMOOTHING ERROR (POST PROCESS)

The ultimate smoothed trajectory is our reference trajectory: we have no further reference to which we could qualify its own accuracy.

Our appreciation of its accuracy is finally only based on the error envelopes predicted by PopINS. We have two reasons why to be confident with this prediction. First, the envelop and the actual error well agreed in the preliminary test. Moreover, the envelops over the 24 hours of tests seem coherent with the errors we can expect if we consider that these errors might be half those reached in Real Time.

For each test, we present the following graphics (cf. Figure 7):

on left page, a bird view, with a marker (\*) every 5 minutes

on right page, several time series:

- clock drift between LandINS and PPS
- speed estimation derived from PopINS positions (dP/dt)
- PopINS speed (V)
- predicted envelop in latitude (1 RMS)
- predicted envelop in longitude (1 RMS)
- predicted envelop in altitude (1 RMS)

Note: at the very beginning of each test, PopINS positions are aberrant for several tenths of seconde, which cause a systematic pick visible when deriving. This corresponds to the arrival of the first PPS that synchronizes LandINS and reset the position.

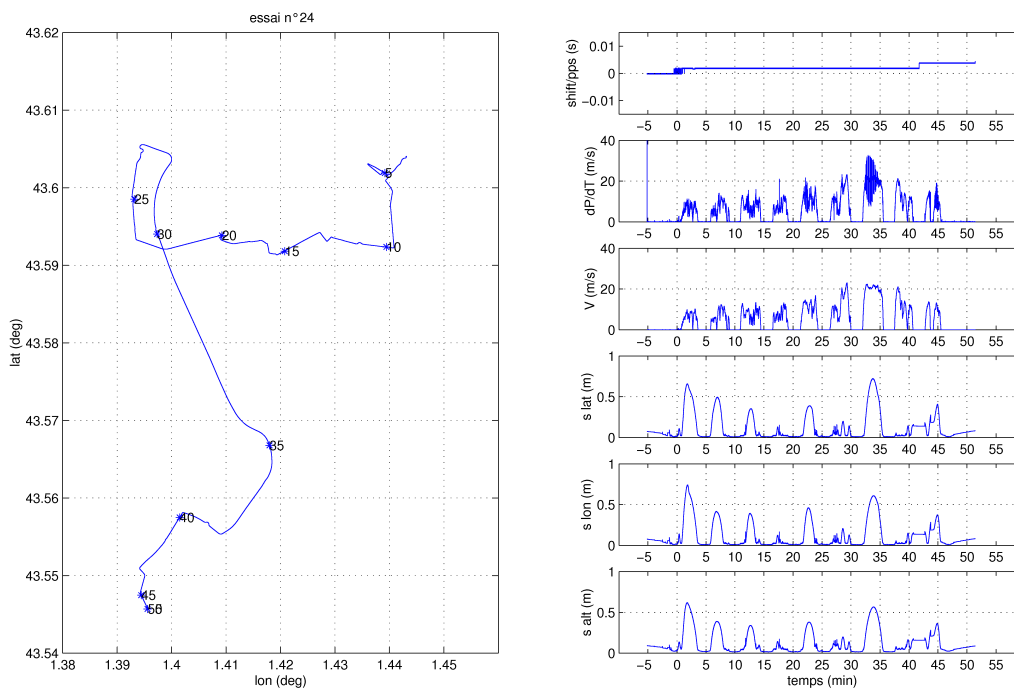

**Figure 7 - reference trajectory delivered for test n°24**

Next frames give the percentage of test time when PopINS horizontal envelop is below 0.5m (1 RMS), and the percentage of this test time when the test vehicle was actually moving.

Session 1 (10h to 19h local time).

10h	99%	47%
11h	96%	35%
12h	100%	43%
13h	99%	42%
14h	100%	33%
15h	96%	38%
16h	100%	36%
17h	96%	36%
18h	100%	39%

Session 2 (04h to 10h local time).

04h	98%	45%
05h	95%	43%
06h	96%	44%
07h	100%	41%
08h	100%	42%
09h	100%	44%

Session 3 (19h to 04h local time).

19h	100%	41%
20h	80%	36%
21h	96%	38%
22h	98%	41%
23h	97%	40%
00h	94%	45%
01h	84%	39%
02h	96%	39%
03h	65%	46%

These frames show that almost everywhere the reference trajectory error bound is within 0.5m (1 RMS), which was our objective for this study. The price to pay was this constraining “stop and go” strategy, which in fact explains why the vehicle actually moved only 40% of the total test duration and otherwise remained static.

Note that each test starts and stops with minimum 5 minutes static for the initialization of LandINS, which already consumes near 20% of the test time.

In the very final series of frames below, we indicate the performed distance (in m) with kinematic GPS only, and the total performed distance. The ratio is given in percentage.

Session 1 (10h to 19h local time).

10h	7537	14983	50%
11h	1091	8299	87%
12h	4725	11022	57%
13h	6157	11365	46%
14h	1593	6203	74%
15h	3817	11313	66%
16h	4309	11408	62%
17h	1129	7447	85%
18h	3921	6647	41%

Session 2 (04h to 10h local time).

04h	6744	15575	57%
05h	3039	11693	74%
06h	6501	16432	60%
07h	7303	12580	42%
08h	2471	7528	67%
09h	4656	10980	58%



Session 3 (19h to 04h local time).

19h	5827	12312	53%
20h	1388	9138	85%
21h	2291	11352	80%
22h	5526	13438	59%
23h	1844	9387	80%
00h	4338	17039	75%
01h	5058	12330	59%
02h	1020	10032	90%
03h	2667	17395	85%

## 7. CONCLUSIONS

Figures 8 and 9 show on the same Google map the available kinematic GPS solutions and the ultimate reference trajectory for the total 24 hours campaign of tests.

Over a total distance of 276km in the city of Toulouse, only 95km were covered by PPK GPS, which brings about 35% availability (in distance) only. There are many discontinuities to cope with inertial navigation and odometry. In conclusion, the reference trajectory is available almost everywhere with an accuracy < 50cm RMS with LandINS. Last but not least, LandINS is accurately timestamped in UTC time, at a much higher sampling rate (100Hz) than most GPS receivers.

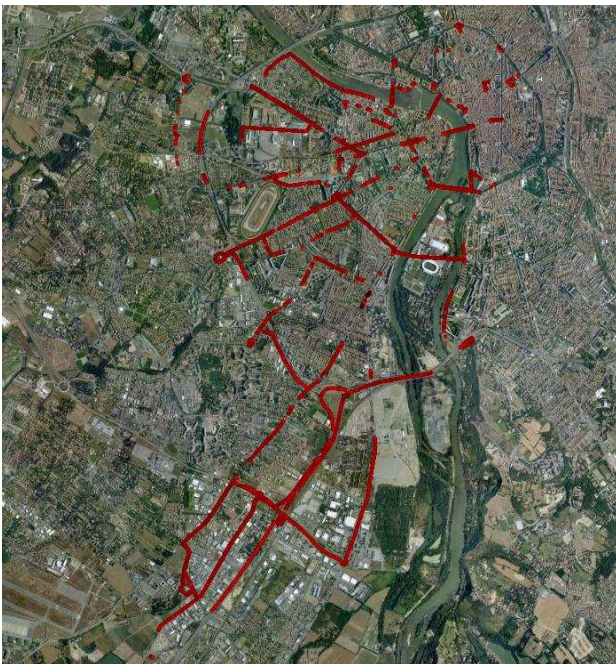

**Figure 8 - PPK solutions only**

## ACKNOWLEDGEMENTS

This program of research on the integrity of urban GNSS positioning is funded by CNES.

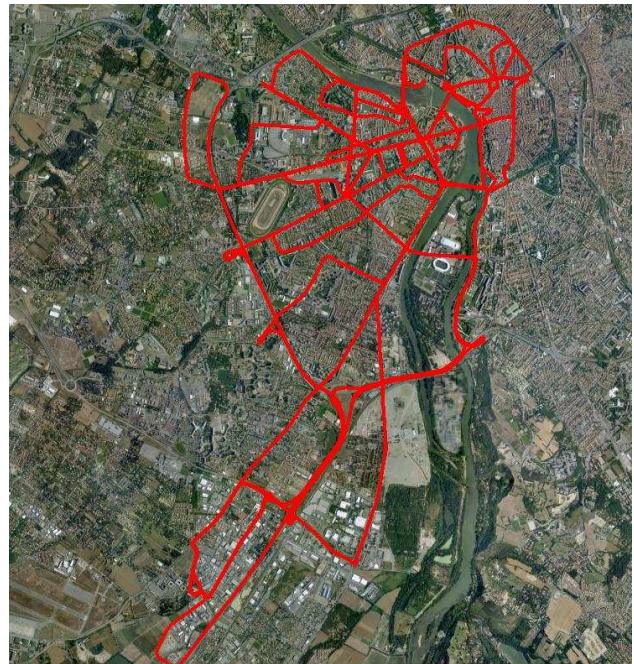

**Figure 9 - Ultimate reference trajectory**

## REFERENCES

- [1] M. Kais, P. Bonnifait, D. Bétaille and F. Peyret, "Development of Loosely-Coupled FOG/DGPS and FOG/RTK Systems for ADAS and a Methodology to Assess their Real-Time Performance", Intelligent Vehicles, 2005.
- [2] D. Bétaille, B. Lusetti, A. Chapelon, M. Kais and D. Millescamps, "High Integrity Reference Trajectory for Benchmarking Land Navigation Data Fusion Methods", Intelligent Vehicles, 2007.