



**HAL**  
open science

## Improving Water Quality and Security with Advanced Sensors and Indirect Water Sensing Methods

Philippe Cousin, Anastasia Moumtzidou, Anastasios Karakostas, Lefteris Gounaridis, Christos Kouloumentas, Mauro Fernandes Pereira, Apostolos Apostolakis, Paula Gorrochategui, Guillaume Aoust, Bérengère Lebental

### ► To cite this version:

Philippe Cousin, Anastasia Moumtzidou, Anastasios Karakostas, Lefteris Gounaridis, Christos Kouloumentas, et al.. Improving Water Quality and Security with Advanced Sensors and Indirect Water Sensing Methods. Instrumentation and Measurement Technologies for Water Cycle Management, Springer International Publishing, pp.251-277, 2022, Springer Water, 978-3-031-08262-7. 10.1007/978-3-031-08262-7\_11 . hal-04023982

**HAL Id: hal-04023982**

**<https://univ-eiffel.hal.science/hal-04023982v1>**

Submitted on 30 Jul 2024

**HAL** is a multi-disciplinary open access archive for the deposit and dissemination of scientific research documents, whether they are published or not. The documents may come from teaching and research institutions in France or abroad, or from public or private research centers.

L'archive ouverte pluridisciplinaire **HAL**, est destinée au dépôt et à la diffusion de documents scientifiques de niveau recherche, publiés ou non, émanant des établissements d'enseignement et de recherche français ou étrangers, des laboratoires publics ou privés.



Distributed under a Creative Commons Attribution - NonCommercial - NoDerivatives 4.0 International License

# Improving water quality and security with advanced sensors and indirect water sensing methods

Philippe Cousin and Anastasia Moumtzidou and Anastasios Karakostas and Lefteris Gounaridis and Christos Kouloumentas and Mauro Fernandes Pereira and Apostolos Apostolakis and Paula Gorrochategui and Guillaume Aoust and Bérengère Lebental

---

Philippe Cousin  
EGM, France, e-mail: philippe.cousin@egm.io

Anastasia Moumtzidou  
ITI-CERTH, 6th km Harilaou - Thermi, 57001, Thermi - Thessaloniki, Greece e-mail: moumtzid@iti.gr

Anastasios Karakostas  
ITI-CERTH, 6th km Harilaou - Thermi, 57001, Thermi - Thessaloniki, Greece e-mail: akarakos@iti.gr

Lefteris Gounaridis  
National Technical University of Athens, Athens 15573, Greece e-mail: lgou@mail.ntua.gr

Christos Kouloumentas  
National Technical University of Athens, Athens 15573, Greece e-mail: ckou@mail.ntua.gr,  
Optagon Photonics, Athens 15341, Greece e-mail: christos.kouloumentas@optagon-photonics.eu

Mauro Fernandes Pereira  
Department of Physics, Khalifa University of Science and Technology, Abu Dhabi UAE e-mail: mauro.pereira@ku.ac.ae,  
Institute of Physics, Czech Academy of Sciences, Prague, Czech Republic e-mail: pereira@fzu.cz

Apostolos Apostolakis  
Institute of Physics, Czech Academy of Sciences, Prague, Czech Republic e-mail: apostolakis@fzu.cz

Paula Gorrochategui  
mirSense, Centre d'intégration NanoINNOV, 91120 Palaiseau, France e-mail: paula.gorrochategui@mirsense.com

Guillaume Aoust  
mirSense, Centre d'intégration NanoINNOV, 91120 Palaiseau, France e-mail: Guillaume.Aoust@mirsense.com

Bérengère Lebental  
Université Gustave Eiffel, COSYS, Marne-La-Vallée, France and Laboratoire de Physique des interfaces et Couches Minces, UMR 7647, Ecole Polytechnique-CNRS, Institut Polytechnique Paris, Palaiseau, France e-mail: berengere.lebental@univ-eiffel.fr

**Abstract** As far as Water is concerned, a lot of new directives and world concerns highlight among others the need for using ICT technologies, the global healthcare issues, the demand for fresh water, the food/beverage quality and safety, the environmental protection and the security strategies to reduce intentional contamination, all of the above having worldwide massive economic, natural and social impacts. However, despite an increasing demand for adaptability, compacity and performances at ever decreasing costs, the vast majority of water network monitoring systems remains based on sensor nodes with predefined and vertical applicative goals hindering interoperability and increasing costs (OPEX and CAPEX) for deploying new and added value services. Innovative technological products could answer the following acute needs in the field. This chapter introduce advance research works in sensing within two H2020 EU projects: the aqua3S project addressing sensors for Water Security purposes and LOTUS addressing low-cost multiparameter sensors for water quality.

## 1 Issues and challenges on water sensing

Water is vital to all forms of life on Earth (human, animal and plant) and its quality is essential for health. It is also an unavoidable component in a wide range of industrial processes, from energy production to construction activities or food production. In spite of this, at least 11% of the European population and 17% of EU territory to date have experienced water scarcity-related problems. Millions of people are killed each year world-wide as a direct consequence of waterborne infectious diseases<sup>1</sup>.

Water supplies are generally spread between surface and groundwater, while usages are highly differentiated between industrial, agricultural and domestic use. Pollution of water supplies is an ever-present risk while drink water losses in the supply network are massive (up to 50% in some cities). Continued management of increasing volumes of waste water, and of evermore frequent exceptional rain events requires increasing investments from water companies and cities.

Therefore, the protection of water quantity and quality is one the cornerstones of environmental protection schemes worldwide. The World Health Organization has placed drinking water quality on top of its priorities list, strongly advocating for the implementation of water safety plans<sup>2</sup>. Strong regulatory norms are being imposed for water quality at the European level<sup>3</sup>, with an ever-increasing number of pollutants of different natures (chemical, biological, agricultural, industrial, pharmaceutical, cosmetic, radioactive, warfare agents) ideally requiring active monitoring.

---

<sup>1</sup> WHO assembly notes: <http://www.who.int/mediacentre/events/2011/wha64/journal/en/index5.html>, [http://www.who.int/water\\_sanitation\\_health/en/](http://www.who.int/water_sanitation_health/en/)

<sup>2</sup> World Health Organization and International Water Association brochure: "A Roadmap to Support Country-Level Implementation of Water Safety Plans" (2010)

<sup>3</sup> European Water Directive, [http://ec.europa.eu/environment/water/index\\_en.htm](http://ec.europa.eu/environment/water/index_en.htm)

## 1.1 Guaranteeing the sustainability of its water cycle is essential to European resilience

Long-term management of such an extended, complex, demanding and strategic aspect of European resources requires widespread, low-cost monitoring means [32] with highly differentiated requirements (from drink water to waste water) and adaptive capabilities (from draught to flood events, from low to high demand levels). Monitoring is needed all along the water distribution cycle, from the water collection points like lakes, rivers and groundwater aquifers, to the reservoir and water pipes that transport it to the consumer. This also applies to the sewage system that takes the used water back to the treatment plants or collecting points.

In addition to the important EU Water Directives, water quality monitoring is also a target of several global challenges reported in the EU Digital Single Market for water services<sup>4</sup> calling to use more ICT and Digital service for Water or the recent EU green deal policies<sup>5</sup> published in 2020 where water will play a pivotal role, particularly for the Clean Energy, Sustainable Industry, Biodiversity, From Farm to Fork and Eliminating Pollution thus heading to the realisation a Water Smart Society according to Water Europe<sup>6</sup>. These documents highlight among others the need for using ICT technologies, the global healthcare issues, the demand for fresh water, the food/beverage quality and safety, the environmental protection and the security strategies to reduce intentional contamination, all of the above having worldwide massive economic, natural and social impacts. However, despite an increasing demand for adaptability, compactness and performances at ever decreasing costs, the vast majority of water network monitoring systems remains based on sensor nodes with predefined and vertical applicative goals hindering interoperability and increasing costs (OPEX and CAPEX) for deploying new and added value services. Innovative technological products could answer the following acute needs in the field:

- **Need for multifunctional probes at low cost:** Typically, 10 different kinds of sensors, each with a unit price in the order of € 300 - € 1000, are required to monitor points of interest in a network, which is not economically viable for large scale deployment. Some multiparameter probes exist on the market but their cost, ranging from € 3.000 to € 25.000, remains a bottleneck towards their widespread use. The issue is further emphasized by the decrease in water consumption, observed notably in Germany, which lowers the turnover for operators of water networks and thus pushes them to limit their investment in monitoring solutions.
- **Need for compactness:** Existing solutions for drinking water monitoring do not fit in the 100mm pipes constituting most of the networks. Their large size often results from lack of integration and non-optimized design, and is in part responsible for the high cost.

<sup>4</sup> Digital Single Market for Water Services Action Plan, <https://ec.europa.eu/futurium/en/system/files/ged/ict4wateractionplan2018.pdf>

<sup>5</sup> [https://ec.europa.eu/info/strategy/priorities-2019-2024/european-green-deal\\_en](https://ec.europa.eu/info/strategy/priorities-2019-2024/european-green-deal_en)

<sup>6</sup> <https://watereurope.eu/>

- **Need for enhanced energy autonomy and resilience:** Permanent power supply isn't always available and there is a need for energy autonomous probe. However, probes could require frequent offline calibrations and maintenance (from 1 to 12 months depending on the product; especially for battery replacement) which is incompatible with permanent monitoring and massive deployment.
- **Need for developing innovative detectors of very high sensitivity:** There is a need to develop a new generation of detectors, whose sensitivity matches the requirements of the end users. In the case of NH<sub>3</sub>, the existing sensors do not deliver the required accuracy, hence our proposal of a QCL-based detector. Note further that the system developed for aqua3S, combining a vaporizer and a QCL+photoacoustic detector is unique and can be adapted for other substances for which either there are currently no sensors or for which the existing commercial sensors can't meet the requirements of the end users.
- **Need for easy and plug&play deployment:** Still a lot of probes are wired and connected to proprietary data systems. Such approaches lead to complex and expensive deployment when there is need for a significant number of probes deployed. With the availability of new long-distance, low energy radio technologies such as Lora, Sigfox, NB-IoT and the coming 5G associated to standardised water data models and brokers (e.g., Fiware4water project<sup>7</sup>) can facilitate the deployment of probes and data exploitation.
- **Need for combining all sources of information to maximize the information alert for security:** There exist several sources that can be used for monitoring the water quality including sensors, satellite data, social media, and drones. Each one of these sources has distinct features that add value to alert raising. Specifically, sensors provide reliable real-time measurements on a local level; satellite provide pollutant identification on a greater scale but in more infrequent intervals; social media introduce the end user's aspect in a direct and prompt way on specific on local level and finally, drones can monitor on-demand and from close distance the area of interest and capture events that may affect water quality. Therefore combining data from the aforementioned sources is a way to balance the advantages and disadvantages of each source and eventually offer a more complete and reliable solution towards alert raising.

## 2 New sensing techniques developed for water security

In order to address the aforementioned challenges, several direct and indirect sensing technologies are under development by the aqua3S project. In the next sections, a general overview of the aqua3S project including all the technologies included, its objective and its impact is provided. Next, the direct and indirect sensing technologies for monitoring water quality are described in detail.

---

<sup>7</sup> <https://www.fiware4water.eu/>

## 2.1 Introduction of aqua3S

aqua3S<sup>8</sup> is a Horizon 2020 funded project that aims at bridging the gap between the technologies related to the analysis of drinking water and their integration to existing water networks towards reducing the exposure of citizens to potential risks. In order to feel this gap aqua3S combines novel technologies in water safety and security into a framework that integrates data from the operators' legacy systems as well. Furthermore, it creates standardized methods and strategies for water safety and security for all involved stakeholders.

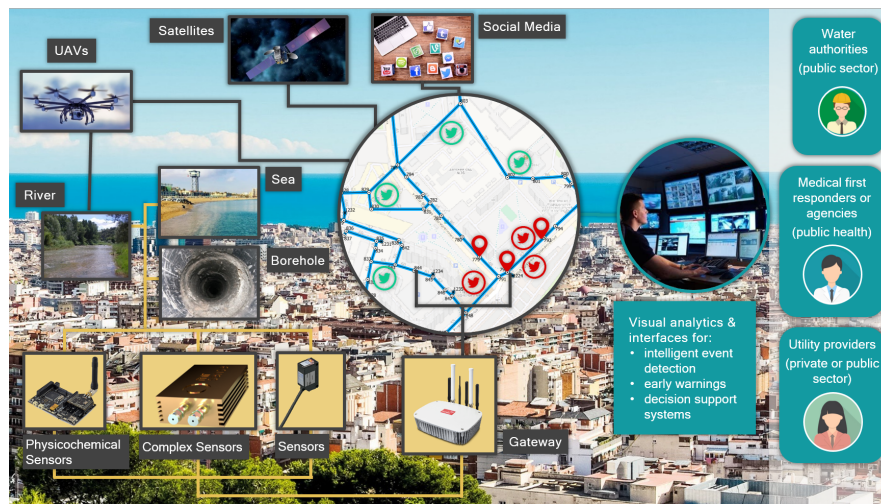

**Fig. 1** Overview of the aqua3S project concept.

Towards this goal, aqua3S integrates a series of state-of-the-art technological achievements from multidisciplinary fields. Specifically, a combination of high precision key point spectroscopic sensors and widely spread refractive index sensors are deployed at fixed points throughout existing water distribution network; on the other hand, sensor measurements are supported by videos from Unmanned Aerial Vehicles, satellite images and social media observations from the citizens that report low-quality water in their area, promoting social interaction with the citizens by: creating social awareness, deploying public warnings and alerts to the public and deploying first responder's mitigation actions and solutions. Furthermore, aqua3S semantically enriches incoming information from multiple sources, capitalising on advanced knowledge representation and intelligent context-based reasoning solutions. Also, in order to aid organizations identify their level of preparedness and resilience in case of a threat crisis, management modeling is realized covering vulnerability of water and water systems from infrastructure attacks, chemical and bio-

<sup>8</sup> <https://aqua3s.eu/>

logical attacks. Moreover, the outcome of the optimised and parallelized algorithms for threat detection and localization, as well as that of the early warning and decision support systems are visualized in a bespoke visual analytics tool. It includes a 3D representation map to offer a highly scalable solution to the potential stakeholders, which supports them during crisis management, delivering full awareness. In order to support decision support, a tool for localised intervention suggestions and a crisis classification module that assesses the severity threat levels are developed. The goal is to provide to the practitioners seamless and valid assessments of the crisis causing by hazardous natural or manmade malicious emergencies. The development of the aforementioned technologies are guided by the user needs and the gaps recognized in the legacy systems. Security requirements are also considered since this objective serves the demands of the water practitioners to safe and secure existing water networks and protects them from natural or malicious hazardous circumstances. The aqua3S platform is evaluated and tested within the operational environment and thus, driven by end-users and experts from the water domain specific pilots design and implement in the field. aqua3S is demonstrated in real use case scenarios in a number of locations, including four large metropolitan cities, Brussels, Paris, Sofia, Thessaloniki, and smaller rural municipalities in Bulgaria, Cyprus and Italy. Last, but certainly not least, aqua3S works towards the standardization and demonstration of strategies and policies to water facilities for the purpose of both safety and security of water. This involves exploring the current and proposed European legal framework regulating water security to understand the current policy requirements and make policy recommendations. Furthermore, current standards and practices being used by water security authorities, industry, policy makers, health care and civil protection across the European Union are identified and assessed to determine standardization gaps, needs and opportunities. Eventually, aqua3S aims at standardizing all the innovative and validated proposed solutions in order to be used by other water authorities beyond the project lifetime.

To sum up, the core objective of aqua3S is to support all the phases in a water related crisis management sequence. Thus, aqua3S aims at improving the awareness of water authorities and companies in relation to a problem by helping the crisis managers to better observe and control their regions, and by improving the collaboration among the involved stakeholders due to reliable and functional connections between the platform end-users. The facilitation of innovative technical solutions also allows water authorities and companies to do more focused and productive crisis management by providing information emerging from various sources to the authorities and by providing a common picture of the situation to all stakeholders and an environment that can be used during preparedness and response for reinforcing communication and information sharing. Finally, aqua3S facilitates the information flow to the water authorities, by considering other communication channels apart from sensors, making possible to inform about an emergency across different devices or services.

## 2.2 Sensor-based techniques

The aqua3S project is engaged in developing and implementing different sensor technologies to strengthen water quality monitoring networks in different European countries. The current challenge here arises from the lack of cost-effective, sensitive and reliable sensors in aquatic systems. On the one hand, the security of supplied water quality commonly requires specific and expensive analysis devices and sensors, whose costs involve greater amounts of financial investment [33]. On the other hand, the use of commercially available sensors for online water analysis is limited by their working range with respect to temperature and humidity and response delays caused by abrupt changes in ambient parameters [9, 44].

aqua3S integrates a series of state-of-the-art technological achievements from multidisciplinary fields, namely of the area of sensors technology, IoT semantic reasoning, high-level analytics, decision support systems, crisis management and situational awareness focusing on water sector. The sensing aqua3S system will consist of a combination of high precision key point spectroscopic sensor and refractive index sensor deployed at fixed points throughout existing water distribution network of a district of interest. The two main types of sensors will be developed and integrated into the security platform of the water utility partners, delivering real time alerts and quantitative information about the presence of water contaminants:

1. A refractive index (RI) sensor, which consists of a single mode, single polarization vertical cavity surface emitting laser (VCSEL) which feeds through a fiber array unit (FAU) a TriPleX chip with 6 parallel sensing asymmetric Mach Zehnder interferometers (aMZIs) . The light collected from the aMZIs is guided with single mode fibers to photodiodes (PDs) and the detected signals are amplified and sampled. The electronic boards that control the VCSEL and the sampling of the detected signals are synchronized. The samples are transferred to the sensing window of the chip via a microfluidic system that comprises a peristaltic pump and proper tubing the interconnects the the sample with the photonic chip.
2. A mid-infrared (MIR) spectroscopic sensor which consists of a gas sensing platform named multiSense [10, 13], integrated with a vaporizer and a microfluid device. The multiSense platform combines an optimized infrared quantum cascade laser (QCL) and a heated photoacoustic cell, permitting the accurate detection of the spectral signature of the vaporized gases of a water sample.

In the following subsections we will provide additional details for the development of the sensors and their properties.

### 2.2.1 Refractive Index sensor

The refractive index (RI) sensor aims to monitor the evaluation of the refractive index of the water samples with remarkably high accuracy and provide early warning signals in case any of the water substances' concentration will increase above the



safe value. The core of the RI sensor is a photonic structure based on asymmetric Mach Zehnder interferometers (aMZIs) that will be integrated onto the photonic integrated circuit (PIC). The vertical external cavity laser (VCSEL) that will be used as light source, the photodiodes (PDs) that will translate the optical signal to a photocurrent, the corresponding electronic controllers and the microfluidic system are equally important components of the RI sensor which were optimized in terms of the water composition changing detection. Therefore, a compact, low-cost device will be prepared together with the high-level digital signal processing (DSP) algorithms will make the RI sensor capable to detect events happening to the water composition with high precision.

### Photonic chip

Passive photonic chips based on a TriPleX platform [43] and having aMZIs as sensing structures, will be used with tapered in- and output that are suited for butt-end coupling to a fiber array unit (FAU), for the detection of the water composition change. The detection mechanism is based on the change of the refractive index in the top-cladding of the aMZIs when different samples are present in this area. This change can be sensed by the evanescent tail of the propagating optical mode, adding a phase delay and afterwards be translated into a wavelength shift of the transfer function (TF) of the aMZIs. (Figure 2).

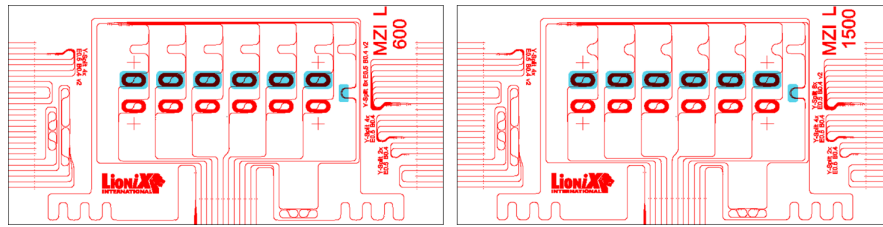

**Fig. 2** The layout of the photonic circuit. It consists of an asymmetric Mach Zehnder interferometer (aMZI) for calibration purposes, an aMZI with very low sensitivity, and a 6-fold array of sensing aMZIs with a common sensing window. Left: sensing aMZIs with 600 pm and Right: sensing aMZIs with 1500 pm FSR, respectively.

Figure 2 presents the layout of the photonic integrated circuit (PIC) in a waveguide structure for single-mode operation at  $850 \text{ nm}$ . It comprises an asymmetric Mach-Zehnder interferometer (aMZI) for calibration purposes, a reference aMZI with sensing window that has been engineered by locally removing the top-cladding silicon oxide layer above the silicon nitride strip and low ( $9.4 \text{ nm/RIU}$ ) in order to be able to follow the very large shift in bulk refractive index changes, and a 6-fold array of sensing aMZIs with a common sensing window. Two different aMZI structures will be used, with two different sensitivities. The structures with  $600 \text{ pm}$  FSR have  $2000 \text{ nm/RIU}$  and the structures with  $1500 \text{ pm}$  FSR have  $5000 \text{ nm/RIU}$  sensitivity, respectively. Both aMZI types, incorporate spiral structures with a sensing pathlength of  $12.5 \text{ mm}$ . A multimode interference (MMI) coupler [15], [17], or

a Y-junction splits on-chip the input light into eight parts in order to feed all the aMZIs. After these elements, the signals are forwarded to the output waveguides that form, together with the input waveguide a 9-fold array with  $127 \mu\text{m}$  pitch.

### Microfluidic system

The RI sensor should be placed in a lake or a piping system where the refractive index of water is constantly monitored, and an immediate flag is risen at a change of it. In order for the RI sensor to have this capability, a microfluidic system is necessary, where the photonic chip can be easily be exchanged and be auto aligned with the fiber array unit embedded in the cartridge. Within the device, the water will be filtered and actively pumped through the cartridge, over the photonic chip, back into the fluidic system or waste. (Figure 3).

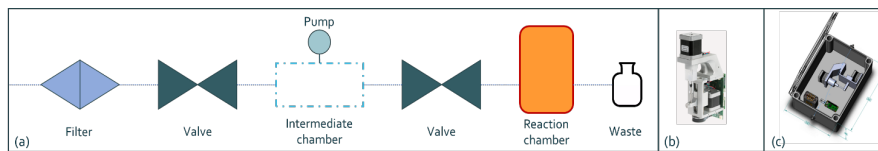

**Fig. 3** Fluidic cartridge (a), microfluidic pump (b) and waterproof packaging (c).

Part of the microfluidic system will be the fluidic cartridge, as it can be seen in Figure 3a. The latter will be non-disposable and 3D printed with seat for the photonic chip and an alignment structure towards embedded fiber array unit. Furthermore, the fluidic cartridge will contain a filter unit with a pore size that will isolate any extensive water substances (e.g., little pebbles and stones, soil) that would be harmful for the sensing photonic chip. Before and after the microfluidic pump (Figure 3b), which will control the flow rate and the volume of the introducing water sample to the sensing area, two valves will be placed for establishing operating water pressure conditions. The photonic chip will be placed in the reaction chamber, followed by an intermediate reservoir which will act as a pre-waste canopy. The final waterproof, 3D printed packaging (Figure 3c), will include the microfluidic system, the control electronics and the battery pack, providing a few hours of autonomous operation.

### Control electronics

The RI sensor will consist of a set of electronic devices and other subsystems, which will be interconnected, enabling the sensor to perform the required individual functions. The operation of all these subsystems will be controlled by an advanced microcomputer with sufficient computing power, memory capacity, number of interface ports and the ability to support different communication protocols with the peripheral elements. (Figure 4).

Raspberry Pi4 was selected as the microcontroller and the micro-computer of RI sensor (Figure 4a). It has a powerful processor as well as high memory capacity. Moreover, the board has a built-in Wi-Fi and Bluetooth transceivers which enhance the microcontroller, with the ability to connect to the internet. With the use of the

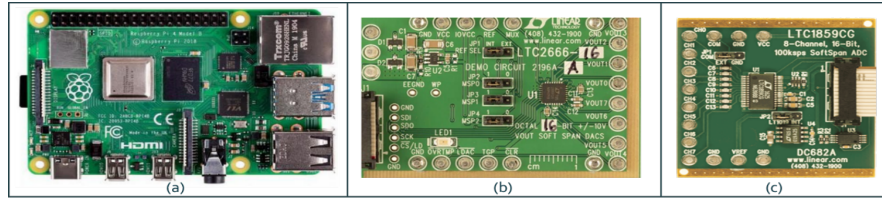
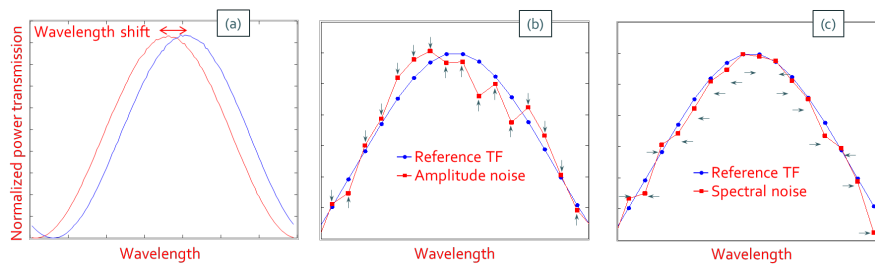

**Fig. 4** Micro-controller/microcomputer based on RPi4 (a), DAC evaluation board (b) and ADC evaluation board (c).

Wi-Fi, the measurement data will be sent to the internet platform and could be collected by a higher-level server for further processing. RPi4 will be responsible for operating the RI sensor, providing the driving signal to the VCSEL source, collecting and processing the data from the aMZI on-chip sensors and controlling the fluidic system. The Digital to Analog Converter (DAC) evaluation board, presented in Figure 4b, will be responsible for generating the analog input signal of the VCSEL. The Analog to Digital Converter (ADC), shown in Figure 4c, will be responsible for digitizing the output signal photocurrent that will be generated by the photodiodes and will be amplified by a transimpedance amplifier (TIA), at an appropriate sampling rate so the digital samples can be further processed by the RPi4 microcontroller.

### Digital Signal Processing (DSP)

The RI sensor will employ a new generation of DSP algorithms that substantially improve the limit of detection of the refractive index change and a new generation of smart algorithms that classify these changes into suspicious ones or not. This powerful method for the processing of the measurement data, the estimation and calculation of the phase delay that these RI changes add on the aMZI transfer functions (TFs), and the corresponding translation into wavelength shift, is based on the fundamental properties of the well-known Fast Fourier Transform (FFT). (Figure 5).



**Fig. 5** Example of wavelength shift (a), representation of amplitude and spectral noise in the TF (b) and (c) respectively.

This measurement data processing method has been evaluated under different levels and types of measurement noise (thermal, spectral, amplitude noise), has taken into account the physical characteristics of the aMZI photonic structures and real system parameters, relevant to the light source, to the photodetectors and to the electronic boards [14, 16]. The RI changes that could be detected, cover the range of Limit of Detection (LoD) from  $10^{-2}$  to  $10^{-7}$  Refractive Index Units (RIU), with ultra-high accuracy ( $\pm 0.5$  pm) describing the efficient nature of the FFT-based algorithm.

### 2.2.2 Quantum Cascade Laser Based Sensor

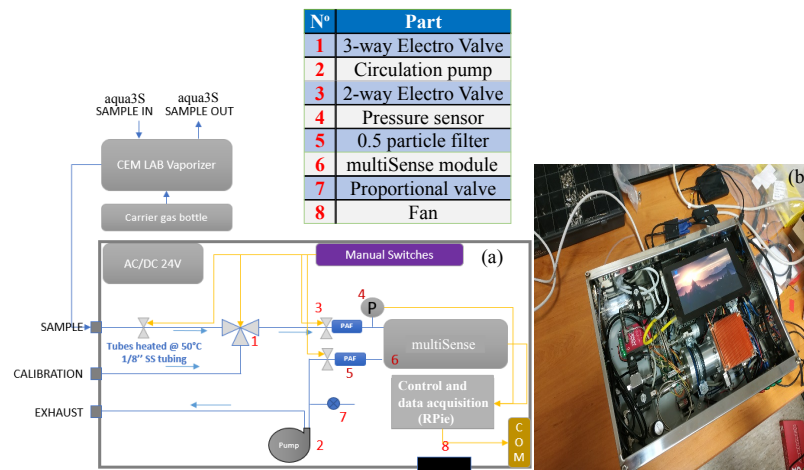
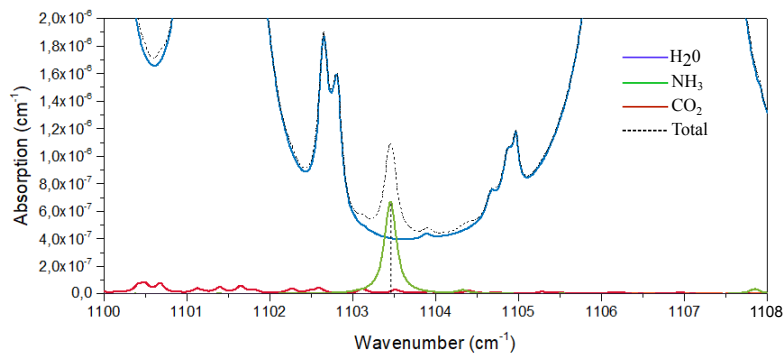

**Fig. 6** (a) Schematic of the whole gas analyzer to be developed in the aqua3S project. (b) The analyzer, including a multiSense OEM sensor.

In this section we present the on-going design and development of a Quantum Cascade Laser (QCL) based sensor for real-time detection of contaminants in water. In this study, we focus on investigating the levels of ammonia in water samples which are commonly monitored by water utility companies that participate in the aqua3S project. In principle, ammonia in water is an indicator of possible bacterial, sewage and animal waste pollution resulting in deterioration of the disinfection efficiency as well as taste and odour problems in drinking water [27]. In order to monitor the changes in ammonia ( $\text{NH}_3$ ) levels we will compare the measured spectral signatures and absorption lines of evaporated water taken from the water distribution system to the absorption lines of  $\text{NH}_3$ . Thus, our detection scheme relies on a sensor that consists of a gas sensing platform named multiSense [13] which has to be integrated in a gas analyzer developed for contaminant sensing in

a water sample. We note that analyzer depicted in Figure 6(a),(b) is a prototype specifically built for the aqua3S project and not a regular product of mirSense. The idea is to vaporize the water sample to obtain a gas sample, the only state of matter suitable for detection within multiSense. The vaporizer is particular suited for precise vapour flow delivery from the water sample allowing the multiSense gas unit to detect the chemical substances (see Figure 6(a)). Furthermore, ammonia molecules in vapor state are compatible with laser photoacoustic spectroscopy in the Mid-Infrared (MIR) region (absorbing light with a wavelength between 3 to 12  $\mu\text{m}$ ), in which multiSense technology operates [13]. Although THz spectroscopic systems based on semiconductor superlattices have been made or proposed [30, 6, 4, 5, 29, 28], trace gas sensing in the mid-infrared using QCLs still promises higher specificity, sensitivity and extended detection limits (Gas dependent, from a few 10s *ppb* to *ppm* level) [12, 13, 10]. These measurement specifications should comfortably fit with the requirements for an ambient  $\text{NH}_3$  sensor. In fact, the advantages of the proposed approach should result in measurements with enhanced accuracy complemented with long-term, unattended and continuous operation in comparison with the existing solutions [44, 9].

The key steps followed for developing the ammonia sensor with enhanced sensitivity can be summarized as follows: (i) Spectroscopy study of the detection of  $\text{NH}_3$  in a humidified gas matrix to identify the laser optimum characteristics, (ii) optimization of the QCL design, in particular tuned for the right wavelength and the minimum amount of power necessary to reach the specification limit of detection, (iii) Fabrication and tests of the optimized QCL, (iv) Design and fabrication of the prototype, combining the multiSense unit, the vaporizer and the necessary gas management surroundings.



**Fig. 7**  $\text{NH}_3$  absorption at  $T = 60\text{ }^\circ\text{C}$ , among the other species of the gas matrix. The vertical dashed line is described in the text.

### QCL wavelength selection

We will now describe in detail the wavelength selection process followed for the detection of ammonia in a vaporized water sample. The gas mix will be considered as air, with a temperature between -10 and 50  $^\circ\text{C}$  and a typical pressure of 1 bar. The

measurement gas cell within multiSense will hence be regulated at 60 °C, 10 °C above the given limit to ensure that the cell temperature will not drift in case of an external temperature of 50 °C. The target molecule will be NH<sub>3</sub>, with a range of detection of 0 to 100 ppm. The limits of detection in the gas phase have been calculated as 15 ppb based on the liquid evaporative method. The allowed measurement time will be considered as 1 s. The wavelength selection process aims to identify the best spectral range to detect target species with multiSense. In order to cover any case, we study the detection of each gas in the most unfavorable gas matrix: (a) The gas of interest is present at its limit of detection, (b) The other interfering species are present at their maximum potential concentration. The first step is to identify the most intense absorption feature, expressed in the unit cm<sup>-1</sup> ppm<sup>-1</sup>. In a second step, the most favorable lines are compared with multiSense performances to evaluate the corresponding limit of detection. The performance of mirSense photoacoustic detection system is given by its normalized noise equivalent absorption (NNEA) defined at 3σ. The minimum detectable absorption is by definition [21]

$$\alpha_{G,min}(3\sigma) = \frac{NNEA}{P_L} \sqrt{\Delta f}, \quad (1)$$

where  $P_L$  is the minimum required power and  $\Delta f$  is the detection bandwidth in Hz. Here the NNEA values are given by the multiSense datasheet as well as the correspondence between the available acquisition frequency and  $\Delta f$  (equivalent noise detection bandwidth). The strongest absorption lines for NH<sub>3</sub> are found between 900 and 1200 cm<sup>-1</sup>. In ambient air, the choice of the wavelength is not only limited to the choice of a strong line, but rather to a choice of interference-free absorption line. Figure 7 demonstrates the strongest absorption lines of NH<sub>3</sub> in the MIR region. One can notice that the main interfering specie is H<sub>2</sub>O (blue line, Figure 7). In order to calculate the minimum required power, we use the detection duration  $T_d$  corresponding to detection bandwidth  $\Delta f = \sqrt{0.3/T_d} = 7 \times 10^{-2}$  Hz and the NNEA of the multiSense unit  $NNEA = 2 \times 10^{-8}$  W cm<sup>-1</sup> Hz<sup>-1/2</sup>. Thus, we estimated a minimum average power,  $P_L = 16.4$  mW, by using for the the targeted wavelength indicated by the vertical line in Figure 7.

### Optimization of the QCL structures

To push QCL based spectroscopy systems to their maximum capabilities, optimization of the QCL structures is needed in combination with accurate simulations. Here, we will perform simulations for QCL structures similar to Ref. [26] designed for light emission near 9 μm which desirable wavelength for the detection. Our methodology can be summarized by the following self-consistent procedure [35, 31]: (a) Solution of the band structure problem including mean field effects due to ionized doping regions to be used as input for the quantum transport and many body solvers, (b) Solution of the Dyson equations describing carrier-phonon, potential fluctuation, impurity scattering and interface roughness mechanisms leading to realistic steady state nonequilibrium distributions. (c) Solution of the nonequilibrium Green's functions equations to determine the current voltage characteristic of the QCLs and (d)

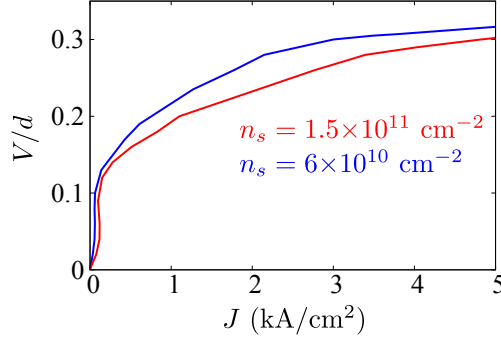

**Fig. 8** Current-voltage characteristics at room temperature for two different doping concentrations.

Solution of the nonequilibrium Green's functions (NEGF) equations for the optical polarization including many body effects. Absorption/gain spectra are obtained in linear response in the field, but they are arbitrarily nonlinear in the carrier density. Conventionally the operation of QCLs is modeled by rate equations between the levels of the active regions, while the current flow through the injector is taken into account phenomenologically. The transition rates can be evaluated microscopically within Fermi's golden rule for electron-electron scattering and phonon scattering. On the other hand, NEGF approach is a more sophisticated approach which allows consistent treatment of the quantum evolution and the scattering processes. To determine now the transport properties of QCL structure under bias, we need the information contained in the following NEGF: the retarded Green's function  $\mathbf{G}^{\text{ret}}$  and the correlation function  $\mathbf{G}^<$ . These functions obey the quantum transport equations that can be delivered from the Hamiltonian  $\hat{H} = \hat{H}_0 + \hat{H}_{\text{scatt}} + \hat{H}_{\text{MF}}$ , where  $\hat{H}_0$  contains the kinetic energy, the superlattice potential, the electric potential due the applied voltage.  $\hat{H}_{\text{scatt}}$  describes the different interaction mechanism leading to electron scattering and which are treated in form of self-energies. Finally  $\hat{H}_{\text{MF}}$  is the mean field due the charge distribution in the heterostructure which is obtained by solving Poisson's equation. We evaluate the current density using the rate of change of the position operator [25]

$$J(t) = \frac{e}{V_s} \frac{i}{\hbar} \langle [\hat{H}, \hat{z}] \rangle, \quad (2)$$

where  $J(t)$  is the average current density flowing in the system volume  $V_s$  and it has two contributions

$$J_0(t) = \frac{e}{\hbar V_s} \text{Tr}\{[\hat{H}_0, \hat{z}] \mathbf{G}^<(t, t')\} \quad \text{and} \quad J'(t) = \frac{e}{V_s} \frac{i}{\hbar} \langle [\hat{H}_{\text{scatt}} + \hat{H}_{\text{MF}}, \hat{z}] \rangle. \quad (3)$$

Numerical applications of our theory for a structure similar to [26] were performed at a room temperature. Figure 8 shows the current-voltage characteristics for different sheet densities  $n_s$ . Once the Green's functions are found and current-voltage relations

calculated, we will re-diagonalise the problem in the Wannier Stark basis, leading to the actual energy states needed for optical processes. The polarization function is calculated leading to the optical susceptibility from which absorption/gain and refractive index changes can be obtained. The calculation of absorption/gain spectra will be compared with transmission spectroscopy measurements of QCLs operating in the mid-infrared.

Currently, we are completing the development activities of the MIR-sensor involving carefully arranged processes of selection, customization and integration of the sensor units to meet the technical requirements determined by the end users of the aqua3S project. Details will be published elsewhere. The new sensor will be integrated into the security platform of water utility partners and tested in field conditions.

## **2.3 Complementing direct sensing by indirect techniques**

This section presents the indirect techniques developed within aqua3S for monitoring water quality. The sources that considered are satellite data retrieved from the Copernicus Open Access Hub and data from social media platforms and specifically from Twitter. These data complement the data from sensors in the task of water monitoring by identifying tweets related to water quality and the existence of pollutants on water surface using satellite data.

### **2.3.1 Area monitoring using satellite data**

In the recent years, the advent of remote sensing technologies provided an abundance of satellite data covering areas all over the world. These collections of information over large spatial areas, are systematically renewed, allowing in a timely manner the characterization of the natural features on the ground or water and observe surface areas. As a result, monitoring how they change over time, helps us determine potential hazards and schedule future action steps.

For the discovery and downloading of satellite images, the Copernicus Open Access Hub has been proved a solid choice. The European Space Agency (ESA)'s platform provides open and immediate accessibility to recent Sentinel products with the possibility to also request and download older archived products that helped with the observation of past incidents. The high availability of the service guarantees a constant source of products with a systematic coverage over most of the continental land surfaces and coastal waters. The supported API allowed to programmatically set the criteria for fetching the required data and feed them to the analysis process. The supported filters include among others the definition of the mission's name, the sensing time, the bounding box of the underlying area of interest, and the product type. The process is executed multiple times within the day in order to timely retrieve the newest products that meet the set requirements.



After a new Copernicus product has been collected, it is passed to either the flood monitoring or oil spill detection analysis algorithms in order to generate the corresponding information maps, depending on the satellite mission name. As far as the *flood monitoring* is concerned, it uses Synthetic Aperture Radar (SAR) data that are captured by the Sentinel-1 constellation. SAR data ignore weather and illumination condition allowing it to penetrate clouds and operate during even nighttime. The aforementioned properties make this satellite type ideal to track flood outbreaks. On the other hand, the *oil spill detection* is based on Sentinel-2 optical data, that provide a more vivid delineation of the captured area and attempts to detect pollutants oil spills on surface water like lakes that pose a threat to the water supply network.

For the flood monitoring algorithm, we applied a change detection technique on a time series of processed Sentinel-1 products. We followed some pre-processing steps that are required in order to transform the Sentinel-1 GRD-IW product to a format that is suitable for further analysis. We applied the orbit file that provides an accurate position of SAR image and performed thermal noise removal, radiometric calibration, speckle noise removal, terrain correction and eventually converted the backscatter intensity values from linear scale to logarithmic. To detect the changes relative to flood, we take into account a time series of the previous 30 satellite images, in order to detect fluctuations when comparing to a normal state of an area. Outlier detection was applied comparing the target image against the time series. For the outlier detection (i.e., the flood areas) [19] we used the formula:

$$\frac{(X - TS_{mean})}{TS_{std}} > \alpha \quad (4)$$

The oil spill detection algorithm takes as input a Sentinel-2 image and splits it into smaller patches. Then it attempts to tackle the hazard as a binary classification problem by predicting the presence of oil spill within each patch of the initial image. The VGG16 (Visual Geometric Group 16) [38] convolutional neural network architecture was selected. We re-trained the four top layers of the VGG16 to fine-tune the network. Eventually the last layer that uses a SoftMax activation was modified in order to support the two output classes of oil and water respectively. For the dataset due to shortage of past incidents and annotated data we created an augmented dataset based on patches of a previous clean image where we artificially added some randomly shaped and colored oil spills. We combined Nir, Green & Swir Sentinel-2 bands to form the composite images, with water appearing transparent, in contrary to oil, shores and other objects that are highlighted in a red color (Figure 9).

In essence, the vast number of sources of satellite imagery allowed the predicting and monitoring over a variety of incidents that occur on earth's surface. With the small interval of the new data on the Copernicus platform makes possible the timely and precise identification of the flooded areas and outbreaks of oil spill events playing a key role in the insurance of public safety against natural phenomena or deliberate actions.



**Fig. 9** Oil spill map of a Balkan lake. With green the successfully identified oil spills. In red the missed oil spills. With yellow the false positives.

### 2.3.2 Social media sensing

The wide adoption of social media in the daily life of billions of people results to large and continuous streams of online content generated by users that can timely reflect what is happening around the globe. Since any topic can be covered nowadays by social media posts, water quality and security is another subject that is expected to concern online users. Thus, we argue that the acquisition of such social media data can serve as an alternative source of information and support the creation of social awareness in a water distribution network.

We have selected to use the social media platform of Twitter for two reasons. First, the platform's high popularity promises prolific and real-time crowd-sourced information. Secondly, Twitter offers various free API endpoints for retrieving tweets, amongst which Twitter Streaming API that allows access to Twitter's public stream of data and retrieves tweets almost at the moment that they are published. Using the filtering option "Track" provided by Streaming API, we are able to retrieve posts whose text contains one or more keywords. Considering that the topic to be monitored on social media is water quality and security, we have specified a set of related keywords to track (e.g., "muddy water", "water odour", "dam pollution", etc.) and each time a newly published tweet matches these criteria, it is instantly retrieved.

After a new tweet has been collected, two analysis techniques are performed to extract further knowledge from the social media data, each one for a different purpose. The *reliability estimation* aims to tackle the growing problem of fake news distributed through social media, by filtering out suspicious posts, while the *automatic geotagging* targets to supplement tweets with geographical information, based on the locations that are mentioned in their text. Both analysis results are appended to the information originally provided by Twitter in order to enrich the tweet (Figure 10).

The reliability is estimated by an automatic verification technique [7] [8] that is able to predict whether a given tweet is real or fake, together with a confidence

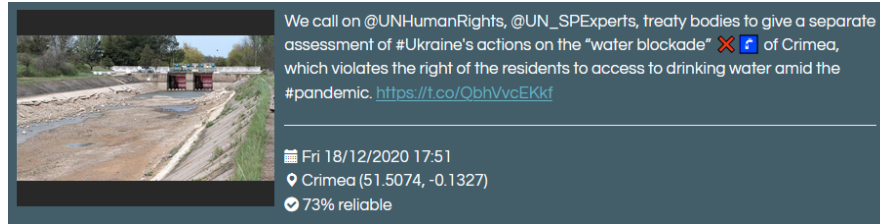

**Fig. 10** Example of a collected tweet, enriched with a reliability score and detected location.

value. It relies on two independent classification models that are built on the same training data, but use different sets of features: tweet-based (e.g., text characteristics, existence of emoticons, number of hashtags, etc.) and user-based (e.g., number of followers, existence of profile image, etc.). After feature extraction is completed, model bagging is applied to obtain more reliable results, based on the predictions of the two classification models, i.e., one from each feature set. The classification algorithm is Logistic Regression, while an agreement-based retraining strategy is performed at prediction time to combine the two bags of models in a semi-supervised learning manner.

The automatic geotagging methodology is motivated by the limited geographical information that Twitter provides and is able to turn tweets into geo-referenced data based on their textual content. In particular, each tweet text is properly preprocessed and is fed to a Bidirectional Long Short-Term Memory model [24] that assigns Named Entity Recognition labels to every qualified word of the text. Single words (e.g., “Rome”) or sets of words (e.g., “River Tiber”) that are recognised as locations are given as query to the OpenStreetMap API<sup>9</sup>, which connects them with open geo-data and responds with the exact WGS84 coordinates. However, it should be noted that this methodology is language-specific.

To sum up, the real-time collection of citizen observations on Twitter based on water-related keywords and their automatic geotagging can serve in the detection and localization of potential incidents of water pollution, either by accident or malevolent acts. In addition, the estimation of the posts’ reliability can improve the quality of incoming information and protect end users from hoax news.

### 3 Low-cost multiparameter water quality monitoring through nanomaterials

Current sensors cost, represents a major blocking factor to largely deploy sensors which are needed to monitor various water quality parameters (usual and new ones) within various water contexts. To address this issues, the H2020 research project

<sup>9</sup> <https://wiki.openstreetmap.org/wiki/API>

PROTEUS(10) followed by LOTUS(11) conduct advanced research which are detailed here after.

### 3.1 Monitoring matrix composition: a challenge of in-situ water quality monitoring

The 2000 EU Water Framework directive includes no less than 12 classes of pollutants and 45 priority substances relevant to water policy in its 2014 consolidated version [1]. This list of priority pollutants and their regulatory thresholds vary across the globe [22]. Even across a reduced spatial perimeter, such as a single lake or river basin or urban water body, the composition of a water matrix, and consequently of water quality, varies strongly spatially and temporally [39] [37] [23].

As a consequence, assessing accurately water quality requires the capability to measure accurately extremely wide range of chemicals in concentrations ranging from sub-ppb to ppm, as well as biological materials. The complexity of the analytical requirements naturally favors the use of off-site laboratory tools, such as those described in [11]. They need to be coupled with on site sampling strategies, which remain to this day economically, practically and scientifically challenging [40].

Naturally, water quality stakeholders would like to bring laboratory methods directly to the field, while bringing down their costs. In practice, the monitoring systems widely available today for real-time water quality are single parameter sensors for temperature, pH, turbidity, (free and total) chlorine, dissolved oxygen, total organic carbon, specific conductance, oxidation reduction potential, fluoride, nitrate, arsenic... This panel of relatively affordable and more or less reliable single parameter sensors (typically from 300€ to 3000€ field-installation-costs not included) is usually used to indicate water contamination but is seldom capable of pointing out the cause of a contamination. Henceforth, it is being progressively complemented by expensive (typically from 3000€ to 15 000€, field-installation-costs not included) and bulky commercial multiparameter probes integrating in a single package several single parameter probes [3].

While these multiparameter probes theoretically satisfy the need for in-situ water composition monitoring, in practice they remain considerably less deployed than monoparameter probes because of their high costs, large size, low versatility, heavy calibration requirement and lack of reliability. The future of in-situ water quality monitoring lies in the capability to offer multiparameter probes with the cost, size, sensing quality, reliability, maintenance requirements of single-parameter sensor probes. This has precisely been the goal of the 2015-2018 H2020 project Proteus<sup>10</sup>, followed by still ongoing H2020 projects LOTUS<sup>11</sup> and Fiware4Water<sup>12</sup>, as well as

---

<sup>10</sup> <http://www.proteus-sensor.eu/>

<sup>11</sup> <https://www.lotus-india.eu/>

<sup>12</sup> <https://www.fiware4water.eu/>

the SATT Paris Saclay project Micad'O<sup>13</sup>, four projects whose outcomes and status we report in the following sections.

### **3.2 Carbon nanotube-based multiparameter water quality sensing: a solution?**

Nanomaterials are highly promising to enable high sensitivity and low cost water quality monitoring [41]. Among nanomaterials, carbon nanotubes (CNTs) have been heavily studied for environmental monitoring due to their excellent chemical stability, their large specific surface area, as well as their commercial availability in bulk at reasonable cost [36]. Notably, CNTs have been reported for electrical sensing in water of pH, micronutrients and metal ions, nitrogen under its different forms, hardness, dissolved oxygen, disinfectants, sulfur under its different forms. However, this remains mostly monoparameter sensing, except for some heavy metals monitored jointly via stripping voltammetry (for example [18] for metals Cadmium, Zinc and Lead). There are also frequent reports on the monitoring of pH jointly with a secondary species [34].

However, beyond these two specific scenarios, there are no report on true multiparameter sensing for water quality monitoring with CNTs. This is surprising because sensor array based on CNTs are regularly reported regarding air quality monitoring [42] or biosensors [2]. The principle of operation of CNT sensor array is as follows: while pristine (e.g., without additives) CNTs have high sensitivity to most analytes, they also have low selectivity between different analytes [45]. To enhance their selectivity, CNTs are functionalized with materials featuring known sensitivity to the target analyte. To enable the detection of several species at the same time, devices incorporating CNT with different functionalizations are located next to each other and their data are correlated to enable accurate derivation of the concentration of target species [20].

During Proteus project, we endeavored to demonstrate at prototype scale the viability of this approach for multiparameter water quality monitoring, as in reported in section 3.3. Following the success of Proteus, ongoing projects aim at bringing the technology at pre-industrial level for field deployment and subsequent commercialization, as is detailed in section 3.4.

### **3.3 Success at prototype level**

During Proteus, we first designed, patented and synthesized a set of polymers [46] suitable to enhance via functionalization the selectivity of CNTs, as shown in Figure 11. CNTs carrying different polymers were integrated into a matrix of chemistors

---

<sup>13</sup> <https://satt-paris-saclay.fr/vitrine-technologique/micado/>

(e.g., resistive devices whose resistance changes with the concentration of the target analyte), as shown in Figure 12. The matrix of chemistors was then cointegrated with microelectronics-based physical sensors (temperature, conductivity, flow rate, pressure). The resulting sensor chip was then co-integrated, jointly with a CMOS-chip-based analog front end, into a sensor head mounted into a waterproof sensor node (Figure 13).

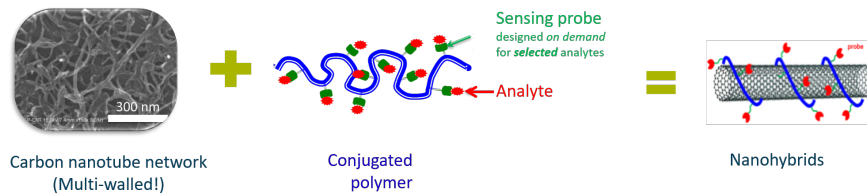

**Fig. 11** Functionalization of carbon nanotubes by conjugated polymers to create nanohybrids capable to detect slectively predefined analytes

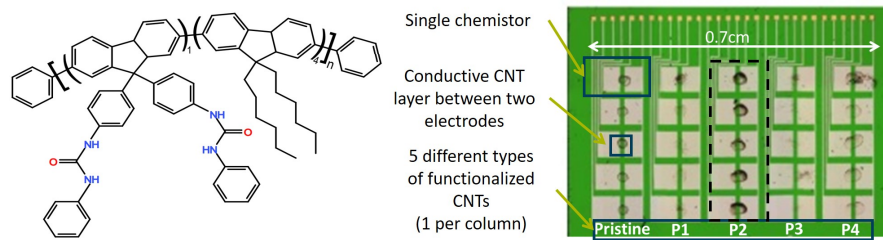

**Fig. 12** Left: Formula of the FF-UR polymer, one of the conjugated polymers used for CNT functionalization. Right: Image of a 5x5 CNT chemistor array with 5 different types of functionalized CNTs

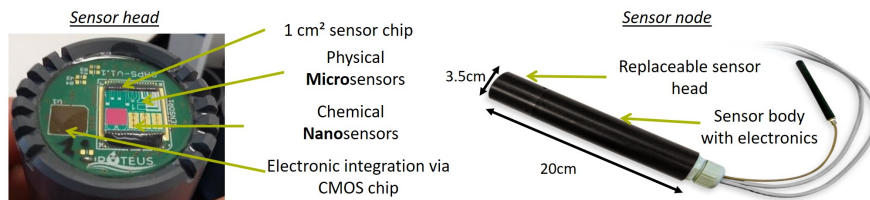

**Fig. 13** Images of (left) a sensor head and (right) a sensor node

The sensor node had the capability, validated at lab level and partially in Sense-City<sup>14</sup> 40m long water loop, to monitor the nine following quantities: temperature, conductivity, pressure, flow rate, pH, Chlorine, Chloride, Nitrate and Calcium. With its size (3.5cm in diameter by 20 cm in length), the sensor node had a volume over ten times smaller in volume than competing commercial solutions, e.g., was close in size with existing single-parameter sensing solutions. In small series production (5 to 10 units), the unit fabrication cost was evaluated at around 550€ only, which made the product already widely competitive with its commercial counterparts. Moreover, numbers clearly showed the capability to reach sales price lower than 1000€ (calibration included) for production volume in the 10 000 units per year.

As synthesized in Figure 14, the sensor node was able to interface with a production SCADA (Supervisory Control and Data Acquisition) system using the MODBUS protocol<sup>15</sup> over a RS485 (wired) or over a LORA (Long Range) (wireless) connection. Alternately, using an event-based architecture inspired from Internet of Things, it could send data to a dedicated cloud using the MQTT (Message Queuing Telemetry Transport) protocol over LORA. It enabled the connection of the system to advanced visualization tools and with machine-learning-based predictive software. The sensor node could also operate completely autonomously in energy via the coupled use of a piezoelectric vortex generator (installed in the drink water pipe), a solar panel, a CMOS-integrated power management unit, an low-power CMOS (complementary metal-oxide semiconductor) analog front end, and finally an adaptive software (state machine) optimizing power consumption based on sensor measurements and energy availability.

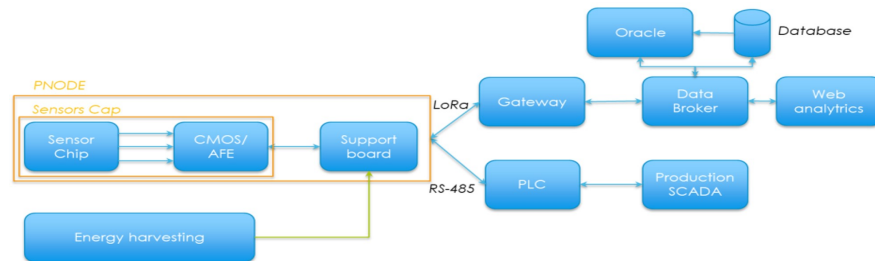

**Fig. 14** IT architecture of Proteus sensor node deployment. AFE: analog front end. PLC: programmable logic controller. SCADA: Supervisory control and data acquisition. Oracle: Proteus-developed IA-based predictive module.

Beside demonstrating the viability of multiparameter water quality monitoring with functionalized carbon nanotube-based chemistor array, the project also showed determining progress beyond state of the art in various fields of science:

<sup>14</sup> <https://sense-city.ifsttar.fr/>

<sup>15</sup> MODBUS is a de facto market standard on communication bus, and it the word originates historically from "modicum communication bus"

- The cointegration of CNT sensors with microelectronic sensors on a single monolithic 1cm<sup>2</sup> silicon chip was at the state of the art regarding both the high number of parameters monitored (9 proved so far) and the high number of sensing elements in a single chip (32 at most).
- Some of the sensing elements inside the chip were completely novel: the flowrate sensor on a silicon chip on the one hand, the CNT-based nitrates, calcium and chloride sensors on the other hand.
- The use of functionalized CNT-based chemistor array for water quality monitoring was novel as well, not to mention that it was the first time such level of integration, with CMOS, MEMS, packaging, energy harvesting and cloud-based data gathering was achieved for CNT-based water quality sensors.
- Regarding the CMOS chip, the ADC design was state of the art, while a completely new design for filtering was implemented. The inductor-free DC-DC converter based in a switched-capacitor topology was also beyond SOTA.
- On the piezoelectric vortex generator for energy harvesting, the results yielded a new understanding of the physics of this type of harvesters. Moreover, field trials prove that energy harvesting is definitely possible from an actual drink water pipe with intermittent flow.
- At software level, Proteus sensor node cognitive capabilities, notably enabling optimized management of energy supply, surpassed the SOTA for commercial devices.

### 3.4 Reaching pre-industrial series for field deployments

Despite its success, Proteus outcomes did not allow for direct commercialization of the technology because of three main factors: high device-to-device performance variability of the chemical sensors, no field validation of system reliability (not permitted within the project time frame) and ownership of the technology building blocks split by different stakeholders (a natural drawback of collaborative projects). Since the conclusion of Proteus, NACRE research team, the joint research team between Université Gustave Eiffel, CNRS and Ecole Polytechnique in France which already coordinated Proteus, has been tackling these challenges through various projects. In short, LOTUS focuses on reproducibility and field deployments of the technology, Fiware4water on its reliability through hardware and software means and Micad'O on its commercial launch through the startup Soterias<sup>16</sup>. The three projects include field testing of the solution to demonstrate its real life suitability.

The first scheduled product monitors temperature, conductivity, chlorine and pH in a single package. It targets 3 months under flow without calibration, for a sales price in the 3,500 € range. Though the selected design - improved from Proteus - allows to target up to 20 different analytes on the same chip in addition to temperature and conductivity, it was elected to reduce the scope of the product for the short term to

---

<sup>16</sup> <https://www.soterias.solutions/>



a limited number of parameters in order to focus more intensively on reproducibility, reliability and industrialization. This first panel of parameters was determined to be the best common denominator between the requirements of the different investigated use cases. Parameters such as hardness, dissolved oxygen, nitrate, fluoride, arsenic and iron are already under investigation for the following versions.

A process to achieve pre-industrial series is now available: sensor chips can be produced with perfect yield and sufficient reproducibility at a rhythm of about 30 chips per week. A process for full sensor node assembly is subsequently available. It could easily reach 100 sensor nodes per month of production capability. While the packaging of the sensor node has remained similar in shape and size to Proteus, the solution is now plug-and-play to any micro computer (RaspberryPi for instance) via a standard USB port. Data is displayed in real-time through Grafana-enabled dashboards. As an option, the sensor can be operated through a connector box specially developed by the company EGM to enable wireless communication (via LORA) and energy autonomy (via solar panel).

Performances and reliability testing started during the last quarter of 2020 and results are preliminary only. Sensing performances are promising: average error on active chlorine, pH and conductivity are around respectively  $0.05 \text{ mg/L}$ ,  $0.2 \text{ pH}$  units and  $20 \text{ }\mu\text{S/cm}$ , while limits of detection lie around  $0.02 \text{ mg/L}$ ,  $0.07 \text{ pH}$  units and  $16 \text{ }\mu\text{S/cm}$ . Longest lifetime is one month and counting of continuous operation in static water, while tests under flow are pending.

The outcomes of these tests are eagerly awaited to launch field deployments during second quarter of 2021. Two deployments in drink water networks are planned, one in Cannes, France, the other in Guwahati, India. A use case enabled by its small size, the solution will also be integrated in a mobile chlorination station outfitting a drink water distribution tanker in Bengaluru, India. It will be also be adapted into a portable solution to diagnose drink water well quality in Guwahati and into a boat-mounted solution to diagnose river quality in Varanasi, India. In parallel, it will be used to optimize irrigation efficiency in Jalgaon, India, and to optimize operations in innovative waste water treatment plants in Warangal and Chennai, India.

These demonstrations will introduce Soterias multiparameter sensor probe to a wide panel of scenarios of water quality monitoring in Europe and India. This is essential to launch commercialization, then to later reach large volume of sales, which in turn will allow to decrease costs and further expand sales. A cost reduction by a factor of 10 is hoped for by stakeholders, which roughly would require sales beyond the 10,000 units range. While this price reduction will be in part achieved through economy of scale, there will be technological challenges to meet for the large volume manufacturing and calibration of CNT-enabled chips.

## 4 Conclusions and Future work

Water is vital for all life and thus its protection is of great importance. Unfortunately, water quality and quantity is under threat due both to natural or man-made disasters.

The World Health Organization and the EU have taken several measures towards its protection, such as strong regulatory norms and implementation of water safety plans. Along with the water directives, several European projects revolve around water safeguarding by developing innovative technological products. As far as the outcome of such research actions are concerned, they involve the development of detection technologies to analyse drinking water and the interconnection of safety- and security-related networks of sensors that are deployed among water supply and distribution networks. The aim of such actions is to check how the use of current sensor technologies, including methods to monitor reservoirs, and sea or river levels for early warning, could support water safety and security.

Regarding the technologies presented in this chapter, they involve the development of new low-cost sensors with high sensitivity that can be installed in several places of the water distribution network and measure single or multiple substances. As far as the aqua3S project is concerned, apart from the direct sensing methods that involve the use of sensors, other innovative indirect sensing methods are presented that involve the use of satellite imagery and social media. These methods although don't have the accuracy of sensors, they offer real-time assessments (social media) or cover larger areas (satellite imagery). The project has also proven that new technologies can help detecting new pollutants. The LOTUS project has also made evidence that advance chip approach (e.g., with MEMS and CNT) can be the solution to produce mass market sensor and thus drastically decreased the cost (i.e., X10 less)

Thus, all together, by exploiting and combining the information offered by all the aforementioned techniques, we are moving towards better monitoring of larger parts of the networks including the water sources and water distribution network and eventually, we are making a step towards ensuring water safety and security. What is of utmost importance to stress is that water safety and security are part of the "crisis management and civil protection" field, which is prioritized by the European Committee for Standardization and it involves establishing security-related standards that aim at facilitating response, effectiveness, efficiency and cooperation during hazardous events. Thus, with the proposed technologies we are also addressing some of the challenges defined by Mandate M/487 to Establish Security Standards. In complement water quality can be more largely monitored ensuring also water safety for the citizens.

**Acknowledgements** This work was supported by the EC-funded projects H2020-644852-Proteus, H2020-832876-aqua3S, H2020-820881-LOTUS and H2020-821036-Fiware4Water and by the SATT Paris Saclay project Micad'O

## References

1. Directive 2000/60/ec of the european parliament and of the council establishing a framework for community action in the field of water policy (Oct 2000), <http://data.europa.eu/eli/dir/2000/60/2014-11-20>

2. Abbott, J., Ye, T., Qin, L., Jorgolli, M., Gertner, R.S., Ham, D., Park, H.: Cmos nanoelectrode array for all-electrical intracellular electrophysiological imaging. *Nature nanotechnology* **12**(5), 460–466 (2017)
3. Adu-Manu, K.S., Tapparelo, C., Heinzelman, W., Katsriku, F.A., Abdulai, J.D.: Water quality monitoring using wireless sensor networks: Current trends and future research directions. *ACM Transactions on Sensor Networks (TOSN)* **13**(1), 1–41 (2017)
4. Apostolakis, A., Pereira, M.F.: Controlling the harmonic conversion efficiency in semiconductor superlattices by interface roughness design. *AIP Advances* **9**(1), 015022 (2019). <https://doi.org/10.1063/1.5050917>, <https://doi.org/10.1063/1.5050917>
5. Apostolakis, A., Pereira, M.F.: Potential and limits of superlattice multipliers coupled to different input power sources. *Journal of Nanophotonics* **13**(3), 1 – 11 (2019). <https://doi.org/10.1117/1.JNP.13.036017>, <https://doi.org/10.1117/1.JNP.13.036017>
6. Apostolakis, A., Pereira, M.F.: Superlattice nonlinearities for gigahertz-terahertz generation in harmonic multipliers. *Nanophotonics* **9**(12), 3941–3952 (2020)
7. Boididou, C., Papadopoulos, S., Apostolidis, L., Kompatsiaris, Y.: Learning to detect misleading content on twitter. In: *Proceedings of the 2017 ACM on International Conference on Multimedia Retrieval*. pp. 278–286 (2017)
8. Boididou, C., Papadopoulos, S., Zampoglou, M., Apostolidis, L., Papadopoulou, O., Kompatsiaris, Y.: Detection and visualization of misleading content on twitter. *International Journal of Multimedia Information Retrieval* **7**(1), 71–86 (2018)
9. Cämmerer, M., Mayer, T., Penzel, S., Rudolph, M., Borsdorf, H.: Application of low-cost electrochemical sensors to aqueous systems to allow automated determination of nh3 and h2s in water. *Sensors* **20**(10), 2814 (2020)
10. Carras, M., Aoust, G., Maisons, G., Brun, M., Spitz, O., Grillot, F.: Quantum cascade laser technology and applications at mirsense, from spectroscopy to chaotic communication (2019)
11. Coquery, M., Morin, A., Bécue, A., Lepot, B.: Priority substances of the european water framework directive: analytical challenges in monitoring water quality. *TrAC Trends in Analytical Chemistry* **24**(2), 117 – 127 (2005). <https://doi.org/https://doi.org/10.1016/j.trac.2004.11.004>, <http://www.sciencedirect.com/science/article/pii/S0165993604030894>
12. Dhillon, S., Vitiello, M., Linfield, E., Davies, A., Hoffmann, M.C., Booske, J., Paoloni, C., Gensch, M., Weightman, P., Williams, G., et al.: The 2017 terahertz science and technology roadmap. *Journal of Physics D: Applied Physics* **50**(4), 043001 (2017)
13. Gorrochategui, P., Aoust, G.: multiSense OEM Gas Analyzer Demo Kit General User’s Guide. mirSense
14. Gounaridis, L., Groumas, P., Schreuder, E., Heideman, R., Avramopoulos, H., Kouloumentas, C.: New set of design rules for resonant refractive index sensors enabled by fft based processing of the measurement data. *Optics Express* **24**(7), 7611–7632 (2016)
15. Gounaridis, L., Groumas, P., Schreuder, E., Heideman, R., Katopodis, V., Kouloumentas, C., Avramopoulos, H.: Design of grating couplers and mmi couplers on the triplex platform enabling ultra-compact photonic-based biosensors. *Sensors and Actuators B: Chemical* **209**, 1057–1063 (2015)
16. Gounaridis, L., Groumas, P., Schreuder, E., Tsekenis, G., Marousis, A., Heideman, R., Avramopoulos, H., Kouloumentas, C.: High performance refractive index sensor based on low q-factor ring resonators and fft processing of wavelength scanning data. *Optics Express* **25**(7), 7483–7495 (2017)
17. Gounaridis, L., Groumas, P., Schreuder, E., Tsokos, C., Mylonas, E., Raptakis, A., Heideman, R., Avramopoulos, H., Kouloumentas, C.: Design of ultra-compact multimode interference (mmi) couplers and high efficiency grating couplers in triplex platform as part of a photonic-based sensor. In: *Integrated Optics: Devices, Materials, and Technologies XXIII*. vol. 10921, p. 1092127. International Society for Optics and Photonics (2019)
18. Hwang, G.H., Han, W.K., Park, J.S., Kang, S.G.: Determination of trace metals by anodic stripping voltammetry using a bismuth-modified carbon nanotube electrode. *Talanta* **76**(2), 301 – 308 (2008). <https://doi.org/https://doi.org/10.1016/j.talanta.2008.02.039>, <http://www.sciencedirect.com/science/article/pii/S0039914008001616>

19. Iglewicz, B., Hoaglin, D.C.: How to detect and handle outliers, vol. 16. Asq Press (1993)
20. Jurs, P.C., Bakken, G., McClelland, H.: Computational methods for the analysis of chemical sensor array data from volatile analytes. *Chemical Reviews* **100**(7), 2649–2678 (2000)
21. Kosterev, A.A., Tittel, F.K., Serebryakov, D.V., Malinovsky, A.L., Morozov, I.V.: Applications of quartz tuning forks in spectroscopic gas sensing. *review of scientific instruments* **76**(4), 043105 (2005)
22. Kruse, P.: Review on water quality sensors. *Journal of Physics D: Applied Physics* **51**(20), 203002 (2018)
23. Kuo, Y.M., wen Liu, W., Zhao, E., Li, R., Muñoz-Carpena, R.: Water quality variability in the middle and down streams of han river under the influence of the middle route of south-north water diversion project, china. *Journal of Hydrology* **569**, 218 – 229 (2019). <https://doi.org/https://doi.org/10.1016/j.jhydrol.2018.12.001>, <http://www.sciencedirect.com/science/article/pii/S0022169418309296>
24. Lample, G., Ballesteros, M., Subramanian, S., Kawakami, K., Dyer, C.: Neural architectures for named entity recognition. *arXiv preprint arXiv:1603.01360* (2016)
25. Lee, S.C., Wacker, A.: Nonequilibrium green's function theory for transport and gain properties of quantum cascade structures. *Physical Review B* **66**(24), 245314 (2002)
26. Lyakh, A., Maulini, R., Tsekoun, A., Go, R., Patel, C.K.N.: Multiwatt long wavelength quantum cascade lasers based on high strain composition with 70% injection efficiency. *Optics Express* **20**(22), 24272–24279 (2012)
27. Organization, W.H., et al.: Guidelines for drinking-water quality: incorporating first addendum (2017)
28. Pereira, M.F., Zubelli, J.P., Winge, D., Wacker, A., Rodrigues, A.S., Anfertev, V., Vaks, V.: Theory and measurements of harmonic generation in semiconductor superlattices with applications in the 100 ghz to 1 thz range. *Phys. Rev. B* **96**, 045306 (Jul 2017). <https://doi.org/10.1103/PhysRevB.96.045306>, <https://link.aps.org/doi/10.1103/PhysRevB.96.045306>
29. Pereira, M.F., Anfertev, V.A., Zubelli, J.P., Vaks, V.L.: Terahertz generation by gigahertz multiplication in superlattices. *Journal of Nanophotonics* **11**(4), 1 – 6 (2017). <https://doi.org/10.1117/1.JNP.11.046022>, <https://doi.org/10.1117/1.JNP.11.046022>
30. Pereira, M., Anfertev, V., Shevchenko, Y., Vaks, V.: Giant controllable gigahertz to terahertz nonlinearities in superlattices. *Scientific Reports* **10**(1), 1–9 (2020)
31. Pereira Jr, M., Lee, S.C., Wacker, A.: Controlling many-body effects in the midinfrared gain and terahertz absorption of quantum cascade laser structures. *Physical review B* **69**(20), 205310 (2004)
32. Quevauviller, P.: Emerging tools for monitoring water quality. *J. Environ. Monit* **7**, 545 (2005)
33. Raich, J.: Review of sensors to monitor water quality. European reference network for critical infrastructure protection (ERNICIP) project (2013)
34. Saetia, K., Schnorr, J.M., Mannarino, M.M., Kim, S.Y., Rutledge, G.C., Swager, T.M., Hammond, P.T.: Spray-layer-by-layer carbon nanotube/electrospun fiber electrodes for flexible chemiresistive sensor applications. *Advanced Functional Materials* **24**(4), 492–502 (2014)
35. Schmielau, T., Pereira Jr, M.: Nonequilibrium many body theory for quantum transport in terahertz quantum cascade lasers. *Applied Physics Letters* **95**(23), 231111 (2009)
36. Schroeder, V., Savagatrup, S., He, M., Lin, S., Swager, T.M.: Carbon nanotube chemical sensors. *Chemical Reviews* **119**(1), 599–663 (2019). <https://doi.org/10.1021/acs.chemrev.8b00340>, <https://doi.org/10.1021/acs.chemrev.8b00340>
37. Shi, B., Bach, P.M., Lintern, A., Zhang, K., Coleman, R.A., Metzeling, L., McCarthy, D.T., Deletic, A.: Understanding spatiotemporal variability of in-stream water quality in urban environments – a case study of melbourne, australia. *Journal of Environmental Management* **246**, 203 – 213 (2019). <https://doi.org/https://doi.org/10.1016/j.jenvman.2019.06.006>, <http://www.sciencedirect.com/science/article/pii/S0301479719307881>
38. Simonyan, K., Zisserman, A.: Very deep convolutional networks for large-scale image recognition. *arXiv preprint arXiv:1409.1556* (2014)

39. Singh, K.R., Dutta, R., Kalamdhad, A.S., Kumar, B.: An investigation on water quality variability and identification of ideal monitoring locations by using entropy based disorder indices. *Science of The Total Environment* **647**, 1444 – 1455 (2019). <https://doi.org/https://doi.org/10.1016/j.scitotenv.2018.07.463>, <http://www.sciencedirect.com/science/article/pii/S0048969718329590>
40. Thompson, J., Pelc, C., Jordan, T.: Water quality sampling methods may bias evaluations of watershed management practices. *Science of The Total Environment* p. 142739 (2020). <https://doi.org/https://doi.org/10.1016/j.scitotenv.2020.142739>, <http://www.sciencedirect.com/science/article/pii/S0048969720362689>
41. Vikesland, P.J.: Nanosensors for water quality monitoring. *Nature nanotechnology* **13**(8), 651–660 (2018)
42. Wang, T., Guo, Y., Wan, P., Zhang, H., Chen, X., Sun, X.: Flexible transparent electronic gas sensors. *Small* **12**(28), 3748–3756 (2016)
43. Wörhoff, K., Heideman, R.G., Leinse, A., Hoekman, M.: Triplex: a versatile dielectric photonic platform. *Advanced Optical Technologies* **4**(2), 189–207 (2015)
44. Yaroshenko, I., Kirsanov, D., Marjanovic, M., Lieberzeit, P.A., Korostynska, O., Mason, A., Frau, I., Legin, A.: Real-time water quality monitoring with chemical sensors. *Sensors* **20**(12), 3432 (2020)
45. Zhang, T., Mubeen, S., Myung, N.V., Deshusses, M.A.: Recent progress in carbon nanotube-based gas sensors. *Nanotechnology* **19**(33), 332001 (jul 2008). <https://doi.org/10.1088/0957-4484/19/33/332001>, <https://doi.org/10.1088/0957-4484/19/33/332001>
46. ZUCCHI, G., LEBENTAL, B., LOISEL, L., Ramachandran, S., GUTIÉRREZ, A.F., Wang, X., GODUMALA, M., BODELOT, L.: Chemical sensors based on carbon nanotubes functionalised by conjugated polymers for analysis in aqueous medium (2018)